

ABP-3000 USER

Intel® Core™ U-series Processor (Whiskey Lake) Ultra-slim Fanless
Embedded System, 4 GigE LAN with 2 PoE+, 4 USB, 4 COM,
9V to 50V DC-in, -40°C to 75°C

Manual

Record of Revision

Version	Date	Page	Description	Remark
0.10	2020/07/10	All	Preliminary Release	
1.00	2020/07/13	All	Official Release	
1.10	2020/11/17	7, 14, 15	Update	
1.20	2021/03/24	3, 8	Update	
1.30	2021/06/03	All	Update	
1.40	2022/10/04	91, 92, 93	Update	
1.50	2023/06/13	32, 36	Update	

Disclaimer

This manual is released by Vecow Co., Ltd. for reference purpose only. All product offerings and specifications are subject to change without prior notice. Vecow Co., Ltd. is under no legal commitment to the details of this document. Vecow shall not be liable for direct, indirect, special, incidental, or consequential damages arising out of the use of this document, the products, or any third party infringements, which may result from such use.

Declaration of Conformity

FCC This equipment has been tested and found to comply with the limits for a Class A digital device, pursuant to part 15 of the FCC Rules. These limits are designed to provide reasonable protection against harmful interference when the equipment is operated in a commercial environment. This equipment generates, uses, and can radiate radio frequency energy, and if it is not installed and used in accordance with the instruction manual, it may cause harmful interference to radio communications. Operation of this equipment in a residential area is likely to cause harmful interference in which case the user will be required to correct the interference at his own expense.

CE The products described in this manual comply with all applicable European Union (CE) directives if it has a CE marking. For computer systems to remain CE compliant, only CE-compliant parts may be used. Maintaining CE compliance also requires proper cable and cabling techniques.

Copyright and Trademarks

This document contains proprietary information protected by copyright. No part of this publication may be reproduced in any form or by any means, electric, photocopying, recording or otherwise, without prior written authorization by Vecow Co., Ltd. The rights of all the brand names, product names, and trademarks belong to their respective owners.

Order Information

Part Number	Description
ABP-3000-8665U	ABP-3000, onboard Intel® Core™ i7-8665UE, 4 GigE LAN with 2 PoE ⁺ , 4 USB 3.1, 4 COM, 16 Isolated DIO, 4 M.2, 1 Mini PCIe
ABP-3000-8145U	ABP-3000, onboard Intel® Core™ i3-8145UE, 4 GigE LAN with 2 PoE ⁺ , 4 USB 3.1, 4 COM, 16 Isolated DIO, 4 M.2, 1 Mini PCIe
ABP-3000 AI-8665U	ABP-3000, onboard Intel® Core™ i7-8665UE, 4 GigE LAN with 2 PoE ⁺ , 4 USB 3.1, 4 COM, 16 Isolated DIO, 3 M.2, 1 Mini PCIe
ABP-3000 AI-8145U	ABP-3000, onboard Intel® Core™ i3-8145UE, 4 GigE LAN with 2 PoE ⁺ , 4 USB 3.1, 4 COM, 16 Isolated DIO, 3 M.2, 1 Mini PCIe

Optional Accessories

Part Number	Description
DDR4 32G	Certified DDR4 32GB 2666MHz RAM
DDR4 16G	Certified DDR4 16GB 2666/2400/2133 MHz RAM
DDR4 8G	Certified DDR4 8GB 2666/2400/2133 MHz RAM
DDR4 4G	Certified DDR4 4GB 2666/2400/2133 MHz RAM
PWA-120WM4P	120W, 24V, 90V AC to 264V AC Power Adapter with 4-pin
M.2 Storage Module	M.2 Key M/Key B PCIe Storage Module
TMK2-20P-100	Terminal Block 20-pin to Terminal Block 20-pin Cable, 100cm
TMK2-20P-500	Terminal Block 20-pin to Terminal Block 20-pin Cable, 500cm
TMB-TMBK-20P	Terminal Board with One 20-pin Terminal Block Connector and DIN-Rail Mounting
5G Module	5G Module with Antenna
4G Module	4G/GPS Module with Antenna
WiFi & Bluetooth Module	WiFi & Bluetooth Module with Antenna

Table of Contents

CHAPTER 1	GENERAL INTRODUCTION	1
	1.1 Overview	1
	1.2 Features	2
	1.3 Product Specification	4
	1.3.1 Specifications of ABP-3000-8665U/3000-8145U	4
	1.3.2 Specifications of ABP-3000 AI-8665U	6
	1.3.3 Specifications of ABP-3000 AI-8145U	8
	1.4 Supported CPU List	10
	1.5 Mechanical Dimension	10
CHAPTER 2	GETTING TO KNOW YOUR ABP-3000	11
	2.1 Packing List	11
	2.2 Front Panel I/O Functions	12
	2.3 Rear Panel I/O Functions	17
	2.4 Main Board Expansion Connectors	21
	2.5 Main Jumper Settings	32
	2.6 Ignition Control	35
CHAPTER 3	SYSTEM SETUP	38
	3.1 How to Open Your ABP-3000	38
	3.2 Installing DDR4 SO-DIMM Modules	40
	3.3 Installing Mini PCIe Card	41
	3.4 Installing M.2	42
	3.5 Installing Antenna Cable	46
	3.6 Installing SIM Card	47
	3.7 Mount Your ABP-3000	48

CHAPTER 4	BIOS SETUP	49
4.1	BIOS Setting	49
4.2	Main Menu	50
4.3	Advanced Functions	50
4.4	Chipset Functions	62
4.5	Security	67
4.6	Boot Functions	69
4.7	Save & Exit	70
APPENDIX A	: Isolated DIO Guide	71
APPENDIX B	: Software Functions	75
APPENDIX C	: RAID Functions	79
APPENDIX D	: Power Consumption	86
APPENDIX E	: Supported List (Memory/M.2)	89
APPENDIX F	: Install Win11 (BIOS TPM Setting)	91

1

GENERAL INTRODUCTION

1.1 Overview

Vecow ABP-3000 Series is powered by 8th Gen Intel® Core™ U-series processor with support for wide range temperature from -40°C to 75°C and wide range 9V to 50V power input. Vecow ABP-3000 Series is designed for edge computing and harsh industrial applications including Machine Vision, In-vehicle Computing, Industrial Automation, Intelligent Control, AMR/AGV, or any AIoT/ Industry 4.0 applications.

ABP-3000 Series features an ultra-slim form factor, only 1.28" in height and it has a complete cable-less design that simplifies the cable routing and ensures system reliability. The system features a small footprint without sacrificing functionality. ABP-3000 Series integrates 4 USB, 4 GigE LAN brought out 2 PoE+, 4 COM RS-232/422/485, 2 SIM sockets and 16 Isolated DIO. To fulfill a variety of different applications requirements, ABP-3000 Series supports an array of M.2 configuration options such as Key B/Key M/Key E, and Mini PCIe for expansions, delivering faster throughput and simplified installation.

Featuring outstanding performance, ultra-slim integration, rugged reliability and compact extensions, ABP-3000 Series is a smart solution for industrial applications including Machine Vision, In-vehicle Computing, Industrial Automation, Intelligent Control, AMR/AGV, or any AIoT/Industry 4.0 applications.

1.2 Features

- 8th Generation Intel® Core™ i U-series processor (Whiskey Lake) supports up to 40% greater productivity than former generation solution
- Ultra-slim and cableless design supports wide range temperature of -40°C to 75°C with fanless operation
- Advanced AI Accelerator supports up to 26 Tera-Operations Per Second (TOPS) with best-in-class power efficiency of 3 TOPS/W
- 2 DDR4 2400MHz memory, up to 64GB
- Dual independent DisplayPorts display supports up to 4K resolution
- 4-port USB 3.1 support up to 10Gbps data transfer
- 4 Independent GigE LAN with 2 IEEE 802.3at PoE⁺
- SIM Socket for 5G/WiFi/4G/3G/LTE/GPRS/UMTS
- 4 COM RS-232/422/485, 16 Isolated DIO
- 9V to 50V DC wide range Power Input
- Ignition Power Control, TPM 2.0
- Expansion : M.2 Key B, M.2 Key M, M.2 Key E and Mini PCIe
- Optional VHub One-Stop AIoT Solution Service supports OpenVINO based AI accelerator and advanced Edge AI applications

1.3 Product Specification

1.3.1 Specifications of ABP-3000-8665U/3000-8145U

System	
Processor	Quad Core Intel® Core™ i7-8665UE/i3-8145UE Processor (Whiskey Lake)
Chipset	Intel® SoC (Cannon Lake)
BIOS	AMI
SIO	IT8786E
Memory	2 DDR4 2400MHz SO-DIMM, up to 64 GB
Graphics	
Graphics Processor	Intel® UHD Graphics 620
Interface	2 DisplayPort : Up to 4096 x 2304 @60Hz
Ethernet	
LAN 1	GigE LAN by Intel® Ethernet Controller I350
LAN 2	GigE LAN by Intel® Ethernet Controller I350
PoE	
LAN 3	GigE IEEE 802.3at (25.5W/48V) PoE+ by Intel® I350 with Power On/Off Control
LAN 4	GigE IEEE 802.3at (25.5W/48V) PoE+ by Intel® I350 with Power On/Off Control
Audio	
Audio Codec	Realtek ALC888S-VD, 7.1 Channel HD Audio
Audio Interface	1 Mic-in, 1 Line-out
Storage	
M.2	<ul style="list-style-type: none">• 1 M.2 Key M Socket (PCIe x4/SATA)• 1 M.2 Key B Socket (PCIe x2/SATA)
I/O Interface	
Serial	4 COM RS-232/422/485 (ESD 8KV)
USB	4 USB 3.1 (External)
Isolated DIO	16 Isolated DIO : 8 DI, 8 DO
LED	HDD, PoE
SIM Card	2 Internal SIM Card Socket

Expansion	
M.2	<ul style="list-style-type: none"> • 1 M.2 Key E Socket (PCIe x1) • 1 M.2 Key B Socket (PCIe x2/USB 3.1)
Mini PCIe	1 Mini PCIe for PCIe/USB/SIM Card
Power	
Power Input	9V to 50V DC-in
Power Interface	Mini DIN
Ignition Control	16 Mode
Remote Switch	3-pin Terminal Block : On, Off, IGN
Others	
TPM	Optional Infineon SLB9665 supports TPM 2.0, LPC Interface
Watchdog Timer	Reset : 1 to 255 sec./min. per step
Smart Management	Wake on LAN, PXE supported
HW Monitor	Monitoring temperature, voltages. Auto throttling control when CPU overheats.
Software Support	
Microsoft	Windows 10
Linux	Fedora 19, Ubuntu 10.04 LTS, or Linux Kernel 3.0 above
Mechanical	
Dimension (W x L x H)	224.0mm x 149.0mm x 32.6mm (8.82" x 5.87" x 1.28")
Weight	1.4 kg (3.09 lb)
Mounting	Wallmount by mounting bracket
Environment	
Operating Temperature	-40°C to 75°C (-40°F to 167°F)
Storage Temperature	-40°C to 85°C (-40°F to 185°F)
Humidity	5% to 95% Humidity, non-condensing
Relative Humidity	95% at 75°C
Shock	<ul style="list-style-type: none"> • IEC 60068-2-27 • SSD : 50G @wallmount, Half-sine, 11ms
Vibration	<ul style="list-style-type: none"> • IEC 60068-2-64 • SSD : 5Grms, 5Hz to 500Hz, 3 Axis
EMC	CE, FCC, EN50155, EN50121-3-2

1.3.2 Specifications of ABP-3000 AI-8665U

System	
Processor	Quad Core Intel® Core™ i7-8665UE Processor (Whiskey Lake)
Chipset	Intel® SoC (Cannon Lake)
BIOS	AMI
SIO	IT8786E
Memory	2 DDR4 2400MHz SO-DIMM, up to 64 GB
AI Accelerator	
Processor	Hailo-8™ AI Processor, up to 26 TOPS
Framework	TensorFlow, ONNX
Graphics	
Graphics Processor	Intel® UHD Graphics 620
Interface	2 DisplayPort : Up to 4096 x 2304 @60Hz
Ethernet	
LAN 1	GigE LAN by Intel® Ethernet Controller I350
LAN 2	GigE LAN by Intel® Ethernet Controller I350
PoE	
LAN 3	GigE IEEE 802.3at (25.5W/48V) PoE+ by Intel® I350 with Power On/Off Control
LAN 4	GigE IEEE 802.3at (25.5W/48V) PoE+ by Intel® I350 with Power On/Off Control
Audio	
Audio Codec	Realtek ALC888S-VD, 7.1 Channel HD Audio
Audio Interface	1 Mic-in, 1 Line-out
Storage	
M.2	1 M.2 Key B Socket (PCIe x2/SATA)
I/O Interface	
Serial	4 COM RS-232/422/485 (ESD 8KV)
USB	4 USB 3.1 (External)
Isolated DIO	16 Isolated DIO : 8 DI, 8 DO
LED	HDD, PoE
SIM Card	2 Internal SIM Card Socket

Expansion	
M.2	<ul style="list-style-type: none"> • 1 M.2 Key E Socket (PCIe x1) • 1 M.2 Key B Socket (PCIe x2/USB 3.1)
Mini PCIe	1 Mini PCIe for PCIe/USB/SIM Card
Power	
Power Input	9V to 50V DC-in
Power Interface	Mini DIN
Ignition Control	16 Mode
Remote Switch	3-pin Terminal Block : On, Off, IGN
Others	
TPM	Optional Infineon SLB9665 supports TPM 2.0, LPC Interface
Watchdog Timer	Reset : 1 to 255 sec./min. per step
Smart Management	Wake on LAN, PXE supported
HW Monitor	Monitoring temperature, voltages. Auto throttling control when CPU overheats.
Software Support	
Microsoft	Windows 10
Linux	Fedora 19, Ubuntu 10.04 LTS, or Linux Kernel 3.0 above
Mechanical	
Dimension (W x L x H)	224.0mm x 149.0mm x 32.6mm (8.82" x 5.87" x 1.28")
Weight	1.4 kg (3.09 lb)
Mounting	Wallmount by mounting bracket
Environment	
Operating Temperature	0°C to 60°C (32°F to 140°F)
Storage Temperature	0°C to 70°C (32°F to 158°F)
Humidity	5% to 95% Humidity, non-condensing
Relative Humidity	95% at 75°C
Shock	<ul style="list-style-type: none"> • IEC 60068-2-27 • SSD : 50G @wallmount, Half-sine, 11ms
Vibration	<ul style="list-style-type: none"> • IEC 60068-2-64 • SSD : 5Grms, 5Hz to 500Hz, 3 Axis
EMC	CE, FCC, EN50155, EN50121-3-2

1.3.3 Specifications of ABP-3000 AI-8145U

System	
Processor	Quad Core Intel® Core™ i3-8145UE Processor (Whiskey Lake)
Chipset	Intel® SoC (Cannon Lake)
BIOS	AMI
SIO	IT8786E
Memory	2 DDR4 2400MHz SO-DIMM, up to 64 GB
AI Accelerator	
Processor	Hailo-8™ AI Processor, up to 26 TOPS
Framework	TensorFlow, ONNX
Graphics	
Graphics Processor	Intel® UHD Graphics 620
Interface	2 DisplayPort : Up to 4096 x 2304 @60Hz
Ethernet	
LAN 1	GigE LAN by Intel® Ethernet Controller I350
LAN 2	GigE LAN by Intel® Ethernet Controller I350
PoE	
LAN 3	GigE IEEE 802.3at (25.5W/48V) PoE+ by Intel® I350 with Power On/Off Control
LAN 4	GigE IEEE 802.3at (25.5W/48V) PoE+ by Intel® I350 with Power On/Off Control
Audio	
Audio Codec	Realtek ALC888S-VD, 7.1 Channel HD Audio
Audio Interface	1 Mic-in, 1 Line-out
Storage	
M.2	1 M.2 Key B Socket (PCIe x2/SATA)
I/O Interface	
Serial	4 COM RS-232/422/485 (ESD 8KV)
USB	4 USB 3.1 (External)
Isolated DIO	16 Isolated DIO : 8 DI, 8 DO
LED	HDD, PoE
SIM Card	2 Internal SIM Card Socket

Expansion	
M.2	<ul style="list-style-type: none"> • 1 M.2 Key E Socket (PCIe x1) • 1 M.2 Key B Socket (PCIe x2/USB 3.1)
Mini PCIe	1 Mini PCIe for PCIe/USB/SIM Card
Power	
Power Input	9V to 50V DC-in
Power Interface	Mini DIN
Ignition Control	16 Mode
Remote Switch	3-pin Terminal Block : On, Off, IGN
Others	
TPM	Optional Infineon SLB9665 supports TPM 2.0, LPC Interface
Watchdog Timer	Reset : 1 to 255 sec./min. per step
Smart Management	Wake on LAN, PXE supported
HW Monitor	Monitoring temperature, voltages. Auto throttling control when CPU overheats.
Software Support	
Microsoft	Windows 10
Linux	Fedora 19, Ubuntu 10.04 LTS, or Linux Kernel 3.0 above
Mechanical	
Dimension (W x L x H)	224.0mm x 149.0mm x 32.6mm (8.82" x 5.87" x 1.28")
Weight	1.4 kg (3.09 lb)
Mounting	Wallmount by mounting bracket
Environment	
Operating Temperature	0°C to 60°C (32°F to 140°F)
Storage Temperature	0°C to 70°C (32°F to 158°F)
Humidity	5% to 95% Humidity, non-condensing
Relative Humidity	95% at 75°C
Shock	<ul style="list-style-type: none"> • IEC 60068-2-27 • SSD : 50G @wallmount, Half-sine, 11ms
Vibration	<ul style="list-style-type: none"> • IEC 60068-2-64 • SSD : 5Grms, 5Hz to 500Hz, 3 Axis
EMC	CE, FCC, EN50155, EN50121-3-2

1.4 Supported CPU List

Processor No.	Cores	TDP	Cache	Max. Frequency	ECC Memory
Intel® Core™ i7-8665UE	4	15W	8M	Up to 4.4GHz	N
Intel® Core™ i3-8145UE	2	15W	4M	Up to 3.9GHz	N

1.5 Mechanical Dimension

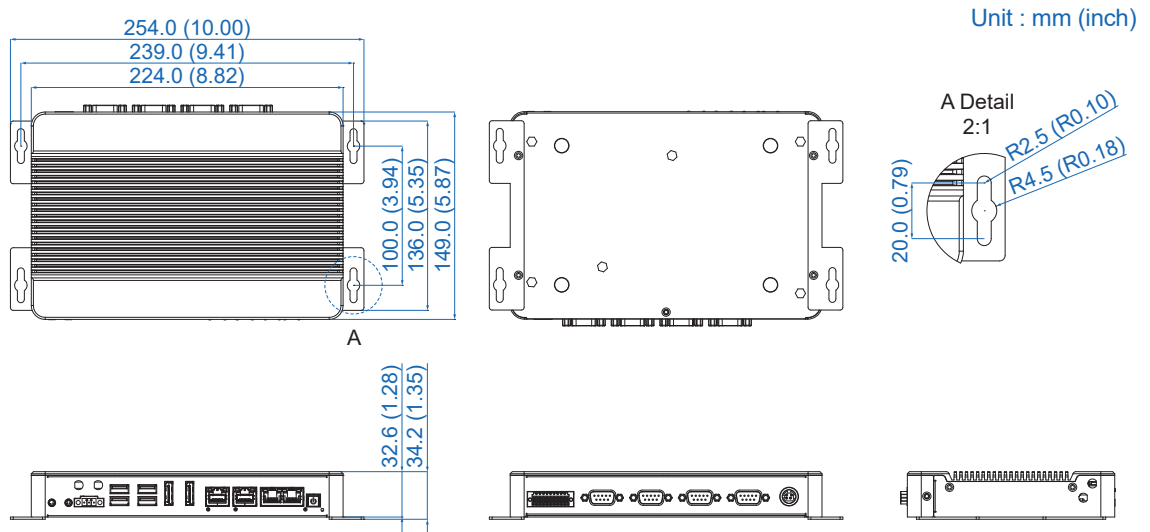

2

GETTING TO KNOW YOUR ABP-3000

2.1 Packing List

Item	Description	Qty
1	ABP-3000 Ultra-Compact Embedded System	1
2	ABP-3000 series accessory box, which contains	

Item	Description	Outlook	Usage	P/N	Qty
3	PHILLPIS M2.5x6L, Ni		Mini PCIe slot	53-2426906-30B	1
4	PHILLPIS M3x6L, Ni+Ny		M.2	53-2426206-80B	3
5	Terminal block 3-pin (3.5mm)		Switch	51-2211R03-S1A	1
6	Terminal block 20-pin (2.54mm)		Isolated DIO/ GPIO	51-2112R20-S1D	1
7	Foot Pad		Foot pad	53-4000042-303	4
8	Wall mount bracket ABP-3000		Mount	62-00P0423-800	2
9	Flat M3x4L, Ni		Wall mount bracket	53-2466204-30B	4
10	M2x2L Ni		M.2 Key B 3042/3052	53-M004600-000	1

2.2 Front Panel I/O Functions

In Vecow's ABP-3000 series family, all I/O connectors are located on front panel and rear panel. Most of the general connections to the computer device, such as audio, USB, LAN, and Display Port, are placed on the front panel.

2.2.1 Reset Tact Switch

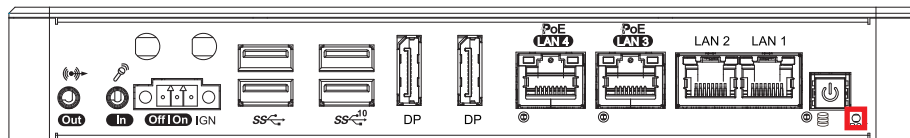

It is a hardware reset switch. Use this switch to reset the system without power off the system. Press the Reset Switch for a few seconds, and then the reset function will be enabled.

2.2.2 Power Button

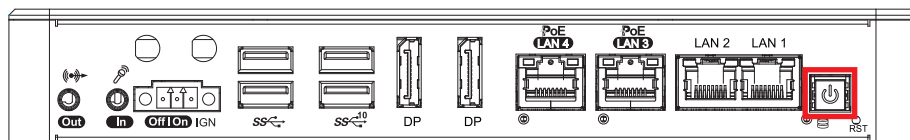

The power button is a non-latched switch with dual color LED indication. It indicates power statuses : S0, S3 and S5. More details on the LED indications are listed in the following chart :

LED Color	Indication	System Status
Solid Blue	S0	System working
Solid Orange	S3, S5	Suspend to RAM, System off with standby power

To power on ABP-3000, press the power button which will light the blue LED.

To power off ABP-3000, you can either command shutdown by OS operation or simply press the power button.

If system error appears, press and hold the power button for four seconds to shut down the machine directly.

Please do note that a four-second interval between each two power-on/power-off operation is necessary in normal working status. (For example, once turning off the system, you have to wait for four seconds to initiate another power-on operation).

2.2.3 HDD LED Indicator

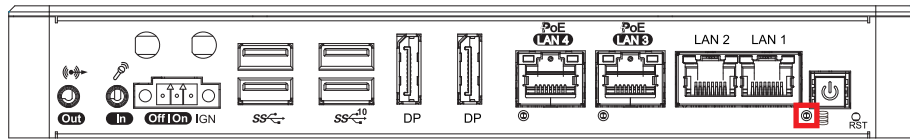

Yellow-HDD LED : A hard disk LED. If the LED is on, it indicates that the system's storage is functional. If it is off, it indicates that the system's storage is not functional. If it is flashing, it indicates data access activities are in progress.

LED Color	Indication	System Status
Yellow	HDD	<ul style="list-style-type: none"> On/Off : Storage status, function or not. Twinkling : Data transferring.

2.2.4 Audio Connector

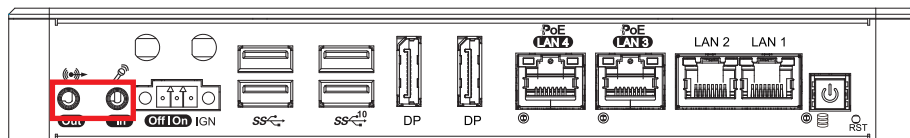

There are two audio connectors, mic-in and line-out, on the front side of ABP-3000. Onboard Realtek ALC888S-VD audio codec supports 7.1 channel HD audio and fully complies with Intel® High Definition Audio (Azalia) specifications.

To utilize the audio function on the Windows platform, you need to install corresponding drivers for Realtek ALC888S-VD codec.

2.2.5 Remote Power On/Off Switch

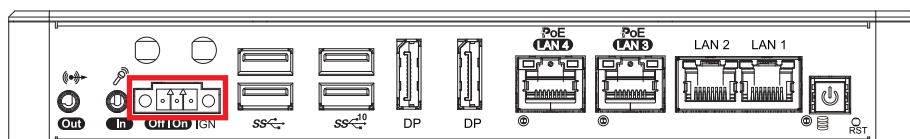

It is a 3-pin power-on/power-off switch through Phoenix Contact terminal block. You could turn on or off the system power by using this contact. This terminal block supports dual function on soft power-on/power-off (instant off or delay four seconds), and suspend mode.

Pin No.	Definition
1	IGNITION
2	SW+
3	SW-

2.2.6 USB 3.1

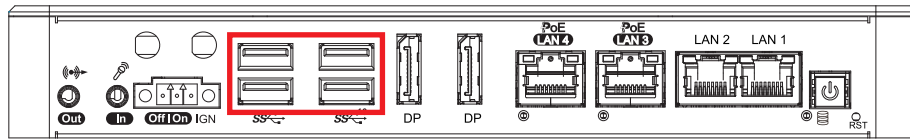

There are 4 USB 3.1 connections available supporting up to 10GB per second data rate in the front side of ABP-3000 series. It also compliant with the requirements of Super Speed (SS), high speed (HS), full speed (FS) and low speed (LS).

2.2.7 Display Port

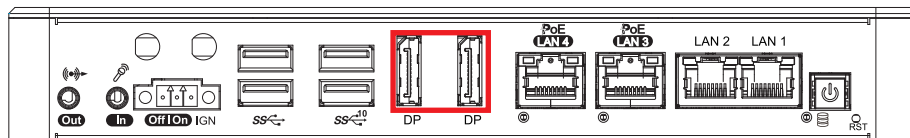

Onboard Display Port support auxiliary channel dual mode, connection supports up to 4096x2304 resolution at 60Hz.

2.2.8 PoE Ports

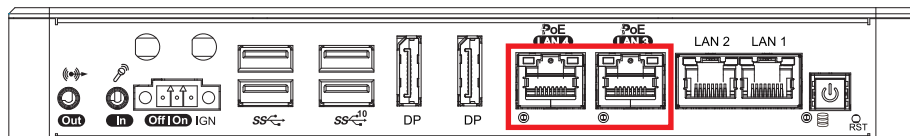

There are 2 RJ45 connectors in the rear side of ABP-3000. It supports IEEE 802.3at (PoE⁺) Power over Ethernet (PoE) connection delivering up to 37W/54V per port and 1000BASE-T gigabit data signals over standard Ethernet Cat 5/Cat 6 cable.

Each PoE connection is powered by Intel[®] I350 Gigabit Ethernet controller and independent PCI express interface to connect with multi-core processor for network and data transmit optimization. Only when PoE port starts to supply power to power devices, the dedicated LED will be lightened.

PS. Suggest to use PoE function when power input is over 12V.

The pin-outs of LAN 3 and LAN 4 are listed as follows :

Pin No.	10/100 Mbps	1000Mbps	PoE
1	E_TX+	MDI0_P	PoE+
2	E_TX-	MDI0_N	PoE+
3	E_RX+	MDI1_P	PoE-
4	-----	MDI2_P	-----
5	-----	MDI2_N	-----
6	E_RX-	MDI1_N	PoE-
7	-----	MDI3_P	-----
8	-----	MDI3_N	-----

Each LAN port is supported by standard RJ-45 connector with LED indicators to present Active/Link/Speed status of the connection.

The LED indicator on the right bottom corner lightens in solid green when the cable is properly connected to a 100Mbps Ethernet network; The LED indicator on the right bottom corner lightens in solid orange when the cable is properly connected to a 1000Mbps Ethernet network; The left LED will keep twinkling/off when Ethernet data packets are being transmitted/received.

LED Location	LED Color	10Mbps	100Mbps	1000Mbps
Right	Green/ Orange	Off	Solid Green	Solid Orange
Left	Yellow	Twinkling Yellow	Twinkling Yellow	Twinkling Yellow

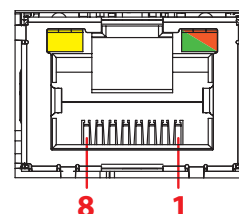

PoE LED	LED Color	PoE Status
LED 1 - 2	Solid Green	PoE ON

2.2.9 10/100/1000 Mbps Ethernet Port

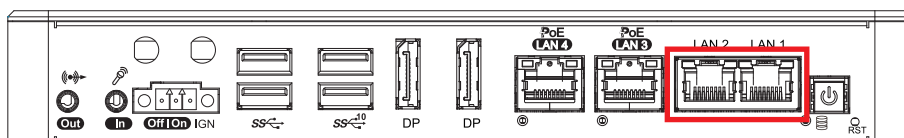

There are two 8-pin RJ-45 jacks supporting 10/100/1000 Mbps Ethernet connections on the front side of ABP-3000. LAN 1 and LAN 2 are powered by Intel® I350 Ethernet engine.

- Intel® I350 Gigabit Ethernet Controller supports 1Gbps data rate
- IEEE 802.3 Fast Ethernet over optical fiber standard compliant
- IEEE 1588 Precision Time Protocol (PTP)
- Up to 9.5KB Jumbo Frame
- Dual 100BASE-FX fiber ports
- Supports Wake-on-LAN (WoL) & PXE

Using suitable RJ-45 cable, you can connect the ABP-3000 system to a computer or to any other devices with Ethernet connection, for example, a hub or a switch. Moreover, both LAN 1 and LAN 2 support "Wake" on LAN and pre-boot functions. The pinouts of LAN 1 and LAN 2 are listed in the following chart :

Pin No.	10/100 Mbps	1000Mbps
1	E_TX+	MDI0_P
2	E_TX-	MDI0_N
3	E_RX+	MDI1_P
4	-----	MDI2_P
5	-----	MDI2_N
6	E_RX-	MDI1_N
7	-----	MDI3_P
8	-----	MDI3_N

Each LAN port is supported by a standard RJ-45 connector with LED indicators to present active/link/speed statuses of the connection.

The LED indicator on the right bottom corner becomes solid green when the cable is properly connected to a 100Mbps Ethernet network; it becomes solid orange when the cable is properly connected to a 1000Mbps Ethernet network. The left LED will keep blinking off when Ethernet data packets are being transmitted or received.

LED Location	LED Color	10Mbps	100Mbps	1000Mbps
Right	Green/ Yellow	Off	Solid Green	Solid Yellow
Left	Green	Blinking Green	Blinking Green	Blinking Green

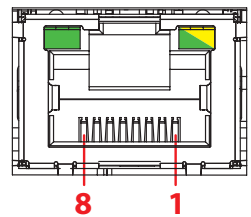

2.3 Rear Panel I/O Functions

2.3.1 Isolated DIO

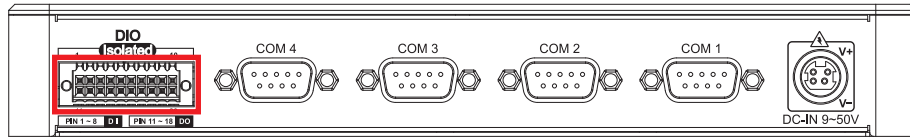

There is a 16-bit (8-bit DI, 8-bit DO) connectors in the rear side. DI/DIO support NPN (sink) and PNP (Source) mode, Each DI channel is equipped with a photocouper for isolated protection.

Each DO with isolator chip, Config by a Jumper for each DIO connector.

DO Safety-Related Certifications :

- 4242-VPK Basic Isolation per DIN V VDE V 0884-10 and DIN EN 61010-1
- 3-KVRMS Isolation for 1 minute per UL 1577
- CSA Component Acceptance Notice 5A, IEC 60950-1 and IEC 61010-1 End Equipment Standards
- GB4943.1-2011 CQC Certified

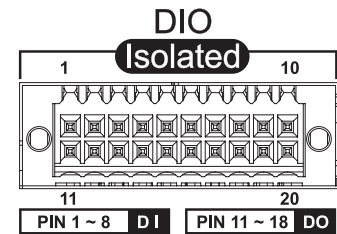

DIO Connectors pin out :

Pin No.	Definition	Function
1	INPUT 0	SIO_GPI80
2	INPUT 1	SIO_GPI81
3	INPUT 2	SIO_GPI82
4	INPUT 3	SIO_GPI83
5	INPUT 4	SIO_GPI84
6	INPUT 5	SIO_GPI85
7	INPUT 6	SIO_GPI86
8	INPUT 7	SIO_GPI87
9	+VDI_COM1	
10	GND_ISO_DIO1	
11	OUTPUT 0	SIO_GPO70
12	OUTPUT 1	SIO_GPO71
13	OUTPUT 2	SIO_GPO72
14	OUTPUT 3	SIO_GPO73
15	OUTPUT 4	SIO_GPO74
16	OUTPUT 5	SIO_GPO75
17	OUTPUT 6	SIO_GPO76
18	OUTPUT 7	SIO_GPO77
19	GND_ISO_DIO1	
20	External 6-40VDC (NPN) External 6-48VDC (PNP)	-

DI reference circuit :

Sink Mode (NPN)

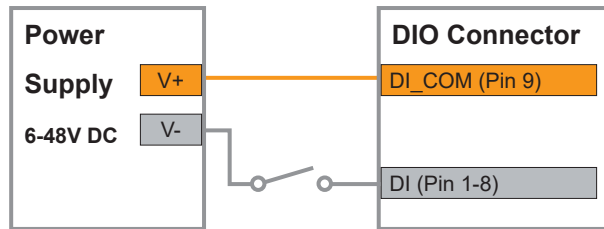

Source Mode (PNP)

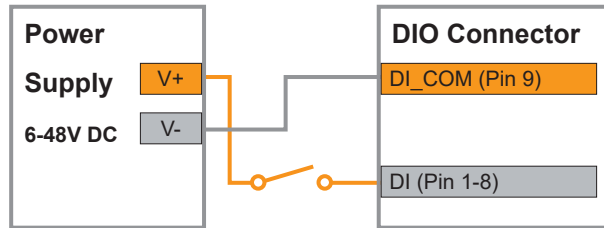

DO reference circuit :

Sink Mode (NPN, Default)

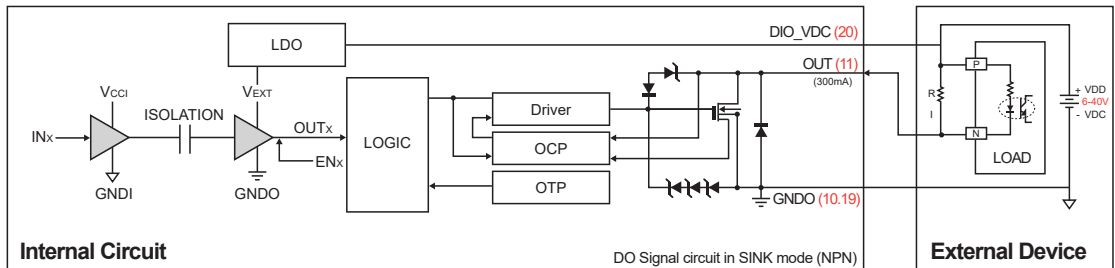

Source (PNP)

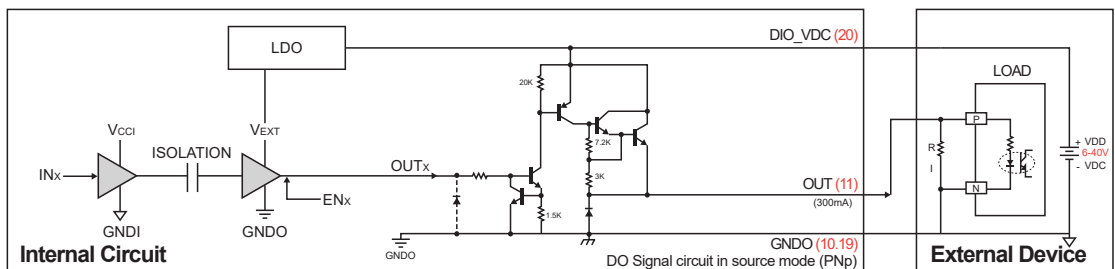

2.3.2 Serial Port

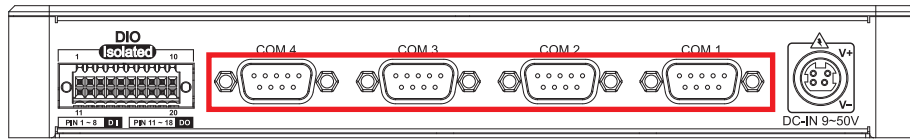

Serial port 1 to 4 (COM 1 to 4) can be configured for RS-232, RS-422, or RS-485 with auto flow control communication. The default definition of COM Ports are RS-232, if you want to change to RS-422 or RS-485, you can find the setting in BIOS.

BIOS Setting	Function
COM 1	RS-232
COM 2	RS-422 (5-wire)
COM 3	RS-422 (9-wire)
COM 4	RS-485
	RS-485 w/z auto-flow control



The pin assignments are listed in the table as follows :

Serial Port	Pin No.	RS-232	RS-422 (5-wire)	RS-422 (9-wire)	RS-485 (3-wire)
1, 2 3, 4	1	DCD	TXD-	TXD-	DATA-
	2	RXD	TXD+	TXD+	DATA+
	3	TXD	RXD+	RXD+	-----
	4	DTR	RXD-	RXD-	-----
	5	GND	GND	GND	GND
	6	DSR	-----	RTS-	-----
	7	RTS	-----	RTS+	-----
	8	CTS	-----	CTS+	-----
	9	RI	-----	CTS-	-----

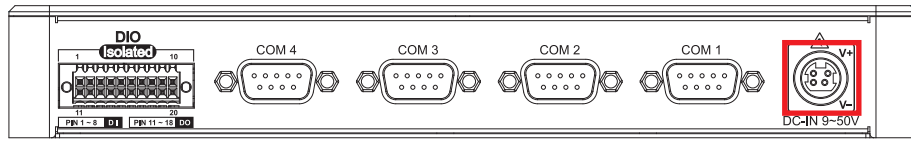
2.3.3 Power Mini Din



ABP-3000 supports 9V to 50V DC power input by Mini Din in the rear side. In normal power operation, power LED lightens in solid green. ABP-3000 supports up to 80V surge protection.

	Pin No.	Definition
	1	V+
	2	V+
	3	GND
	4	GND

2.4 Main Board Expansion Connectors

2.4.1 Top Side View

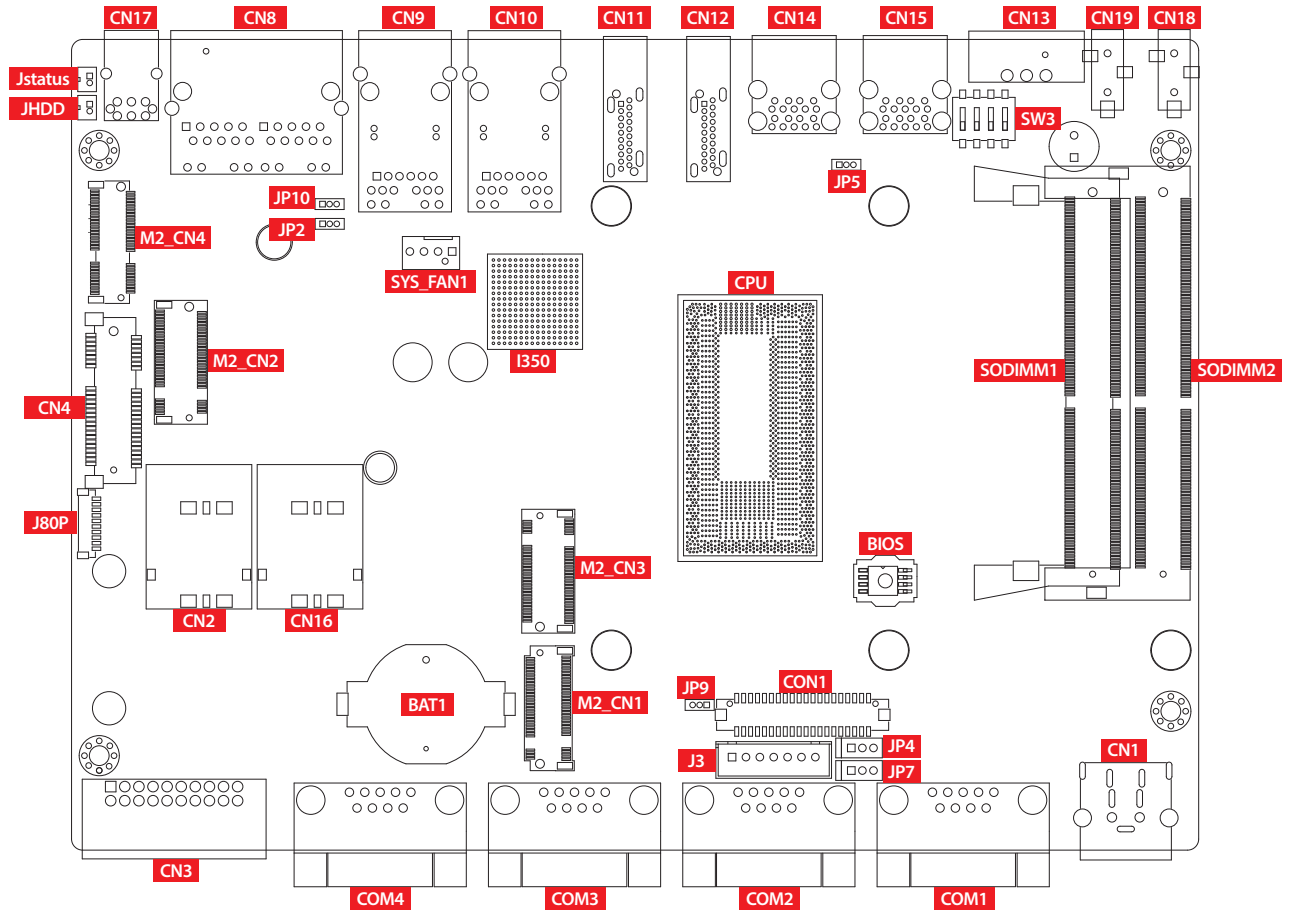

2.4.2 JSTATUS, JHDD : Miscellaneous Pin Header

These pin headers can be used as a backup for the following functions : hard drive LED indicator, power LED indicator, which already can be accessed by front panel and top panel. The pinouts of Miscellaneous port are listed in following table :

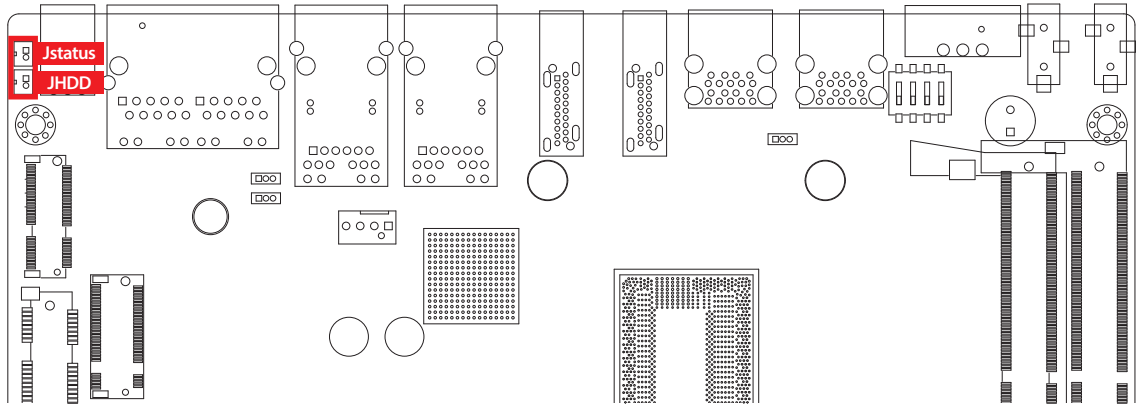

Group	Pin No.	Description
JPWBTN	1	GND
	2	FP_PWR_BTN_IN
JRESET	1	GND
	2	FP_RST_BTN_N
JSTATUS	1	PWR_LED_N
	2	PWR_LED_P
JHDD	1	HDD_LED_N
	2	HDD_LED_P

2.4.3 M2_CN1, M2_CN2, M2_CN3, M2_CN4 : M.2 slot

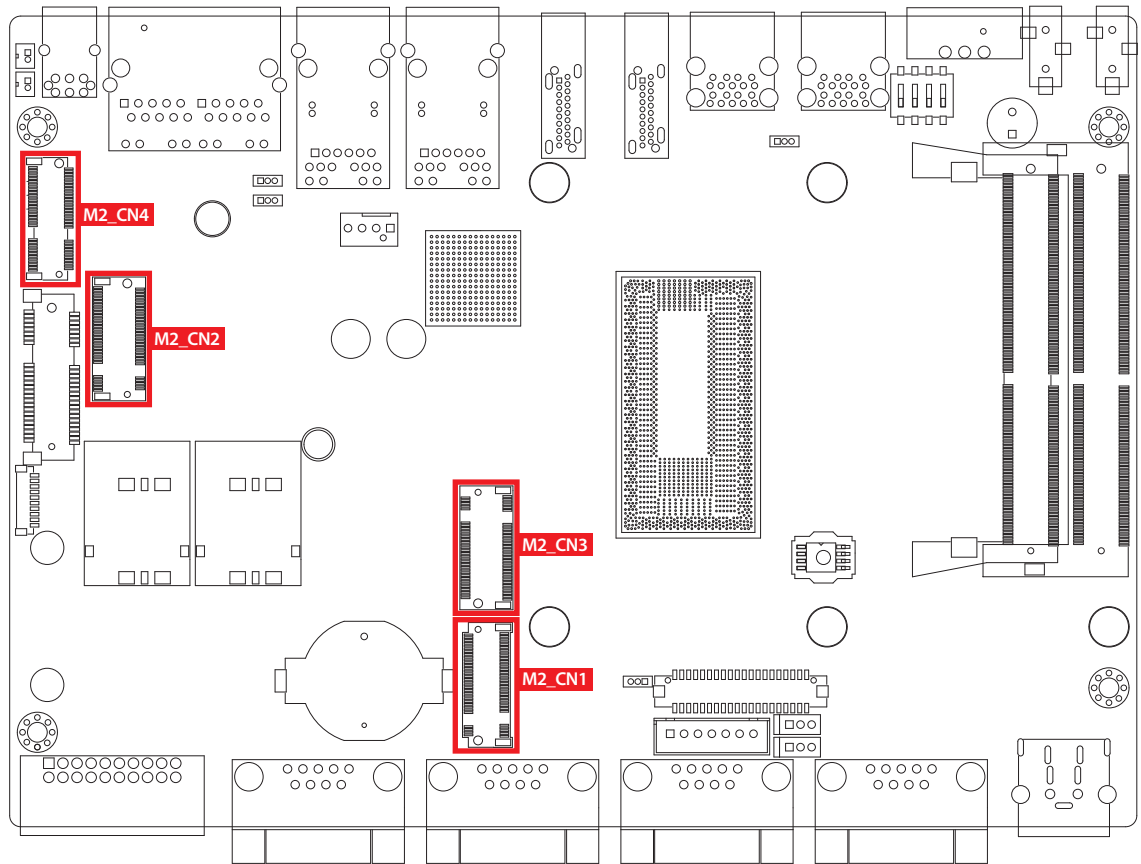

2.4.3.1 M2_CN1 : M.2 KEY M (Dimension : 2280)

Pin No.	Signal Name	Pin No.	Signal Name
75	Ground		
73	Ground	74	3.3V
71	Ground	72	3.3V
69	PEDET	70	3.3V
67	Ground	68	NC
Mechanical Key			
57	Ground	58	NC
55	REFCLKp	56	NC
53	REFCLKn	54	PEWAKE#
51	Ground	52	CLKREQ#
49	PETp0/SATA_A+	50	PERST#
47	PETn0/SATA_A-	48	NC
45	Ground	46	NC
43	PERp0/SATA_B-	44	NC
41	PERn0/SATA_B+	42	NC
39	Ground	40	NC
37	PETp1	38	DEVSLP
35	PETn1	36	NC
33	Ground	34	NC
31	PERp1	32	NC
29	PERn1	30	NC
27	Ground	28	NC
25	PETp2	26	NC
23	PETn2	24	NC
21	Ground	22	NC
19	PERp2	20	NC
17	PERn2	18	3.3V
15	Ground	16	3.3V
13	PETp3	14	3.3V
11	PETn3	12	3.3V
9	Ground	10	LED1#
7	PERp3	8	NC
5	PERn3	6	NC
3	Ground	4	3.3V
1	Ground	2	3.3V

2.4.3.2 M2_CN2 : M.2 KEY B (Dimension : 3042, 3052) for 4G/5G module

Pin No.	Signal Name	Pin No.	Signal Name
		80	Ground
75	NC		
73	Ground	74	3.3V
71	Ground	72	3.3V
69	CONFIG_1	70	3.3V
67	NC	68	NC
65	NC	66	SIM DETECT
63	NC	64	NC
61	NC	62	NC
59	NC	60	NC
57	Ground	58	NC
55	REFCLKp	56	NC
53	REFCLKn	54	PEWAKE#
51	Ground	52	CLKREQ#
49	PETp0	50	PERST#
47	PETn0	48	NC
45	Ground	46	NC
43	PERp0	44	NC
41	PERn0	42	NC
39	Ground	40	NC
37	PETp1/USB3.1-TX+	38	DEVSLP
35	PETn1/USB3.1-TX-	36	UIM-PWR
33	Ground	34	UIM-DATA
31	PERp1/USB3.1-RX+	32	UIM-CLK
29	PERn1/USB3.1-RX-	30	UIM-RESET
27	Ground	28	NC
25	NC	26	NC
23	NC	24	NC
21	NC	22	NC
		20	NC
Mechanical Key			
11	Ground		
9	USB-	10	LED_1#
7	USB+	8	W_DISABLE1
5	Ground	6	FULL_CARD_PWR_OFF/ON
3	Ground	4	3.3V
1	NC	2	3.3V

2.4.3.3 M2_CN3 : M.2 KEY B (Dimension : 2280)

Pin No.	Signal Name	Pin No.	Signal Name
		80	Ground
75	NC		
73	Ground	74	3.3V
71	Ground	72	3.3V
69	CONFIG_1	70	3.3V
67	NC	68	NC
65	NC	66	SIM DETECT
63	NC	64	NC
61	NC	62	NC
59	NC	60	NC
57	Ground	58	NC
55	REFCLKp	56	NC
53	REFCLKn	54	PEWAKE#
51	Ground	52	CLKREQ#
49	PETn0/SATA-A+	50	PERST#
47	PETn0/SATA-A-	48	NC
45	Ground	46	NC
43	PERn0/SATA-B-	44	NC
41	PERn0/SATA-B+	42	NC
39	Ground	40	NC
37	NC	38	DEVSLP
35	NC	36	UIM-PWR
33	Ground	34	UIM-DATA
31	NC	32	UIM-CLK
29	NC	30	UIM-RESET
27	Ground	28	NC
25	NC	26	NC
23	NC	24	NC
21	NC	22	NC
		20	NC
Mechanical Key			
11	Ground		
9	USB-	10	LED_1#
7	USB+	8	W_DISABLE1
5	Ground	6	FULL_CARD_PWR_OFF/ON
3	Ground	4	3.3V
1	NC	2	3.3V

2.4.3.4 M2_CN4 : M.2 KEY E (Dimension : 2230)

Pin No.	Signal Name	Pin No.	Signal Name
75	Ground		
73	NC	74	3.3V
71	NC	72	3.3V
69	Ground	70	PEWAKE1#
67	NC	68	NC
65	NC	66	NC
63	Ground	64	NC
61	NC	62	ALERT
59	NC	60	I2C_CLK
57	Ground	58	I2C_DATA
55	PEWAKE0#	56	NC
53	CLKREQ0#	54	NC
51	Ground	52	PERST0#
49	REFCLKn0	50	NC
47	REFCLKp0	48	NC
45	Ground	46	NC
43	PERn0	44	NC
41	PERp0	42	NC
39	Ground	40	NC
37	PETn0	38	DEVSLP
35	PETp0	36	NC
33	Ground	34	NC
		32	NC
Mechanical Key			
23	NC		
21	NC	22	NC
19	Ground	20	NC
17	NC	18	Ground
15	NC	16	NC
13	Ground	14	NC
11	NC	12	NC
9	NC	10	NC
7	Ground	8	NC
5	USB-	6	LED1#
3	USB+	4	3.3V
1	Ground	2	3.3V

2.4.4 CN4 : Mini PCIe

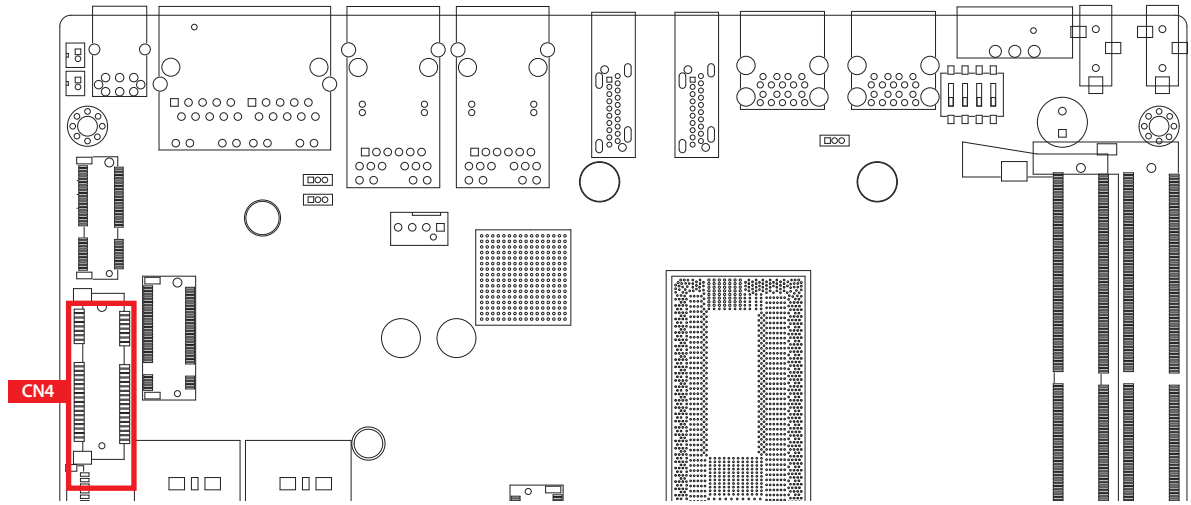

Standard full length mini PCIe slot

The pin assignments of CN4 are listed in the following table :

Pin No.	Signal Name	Pin No.	Signal Name
51	Reserved	52	+3.3Vaux
49	Reserved	50	GND
47	Reserved	48	+1.5V
45	Reserved	46	Reserved
43	SATA_PCIE_SEL	44	Reserved
41	+3.3Vaux	42	Reserved
39	+3.3Vaux	40	GND
37	GND	38	USB_D+
35	GND	36	USB_D-
33	PETp0	34	GND
31	PETn0	32	SMB_DATA
29	GND	30	SMB_CLK
27	GND	28	+1.5V
25	PERp0	26	GND
23	PERn0	24	+3.3Vaux
21	GND	22	PERST#
19	Reserved	20	reserved
17	Reserved	18	GND
Mechanical Key			
15	GND	16	Reserved
13	REFCLK+	14	Reserved
11	REFCLK-	12	Reserved
9	GND	10	Reserved
7	CLKREQ#	8	Reserved
5	Reserved	6	1.5V
3	Reserved	4	GND
1	WAKE#	2	3.3Vaux

2.4.5 CN2, CN16 : SIM Solt

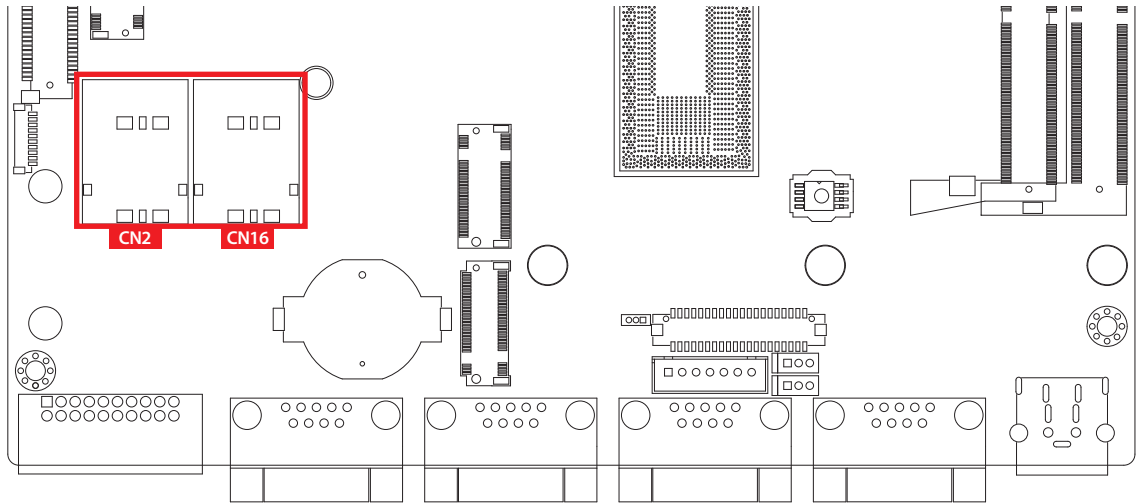

Location	SIM
CN4	CN2
M2_CN2	CN16

2.4.6 SYS_FAN1

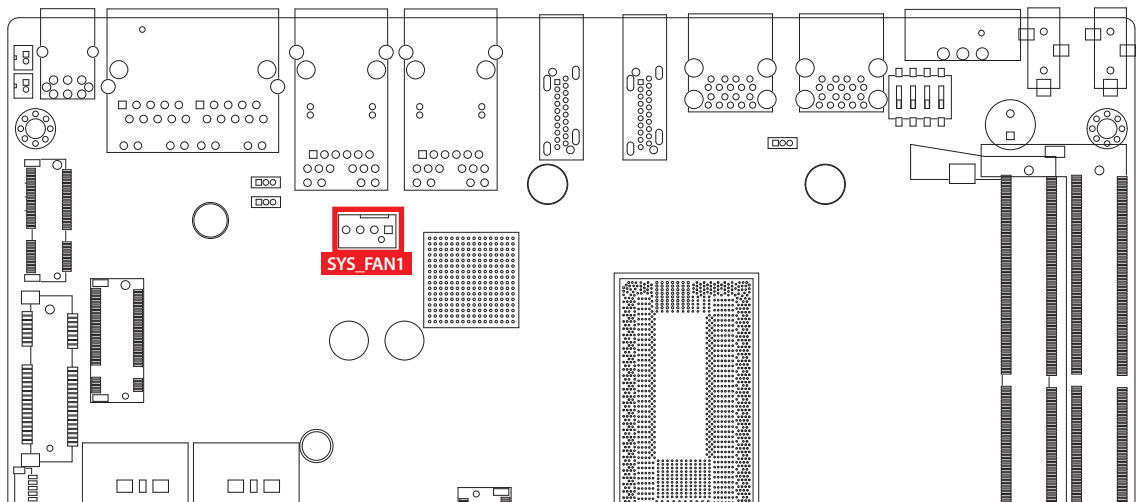

Fan power connector supports higher thermal requirements

Pin No.	Definition	Pin No.	Definition
1	GND	3	Fan speed sensor
2	+12V (1.5A max)	4	Fan PWM

2.4.7 J80P : LPC Port 80 Header

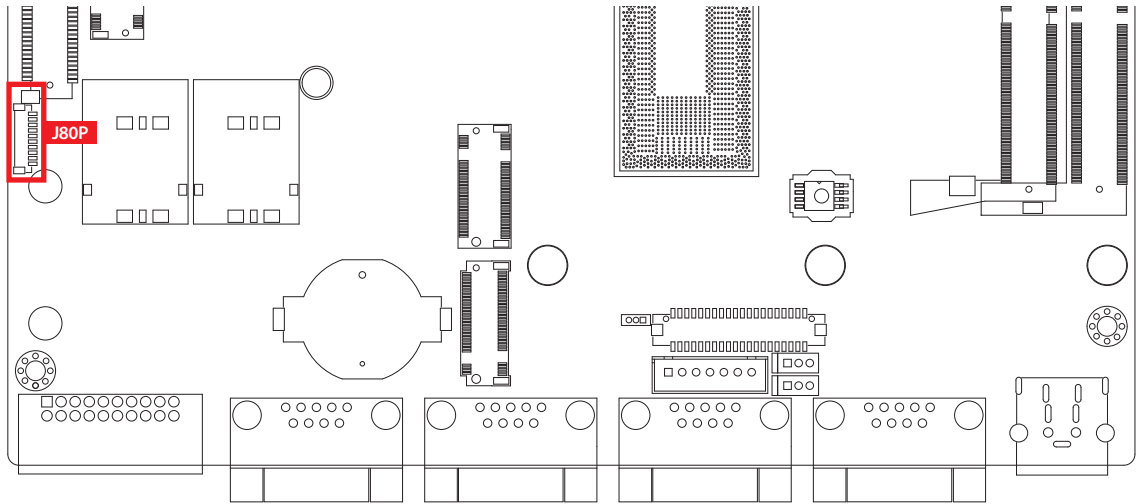

Pin No.	Function	Pin No.	Function
1	+3.3V	2	SERIRQ
3	LAD0	4	LAD1
5	LAD2	6	LAD3
7	LFRAME#	8	CLOCK
9	PLTRST	10	GND

2.4.8 CON1, J3 : LVDS

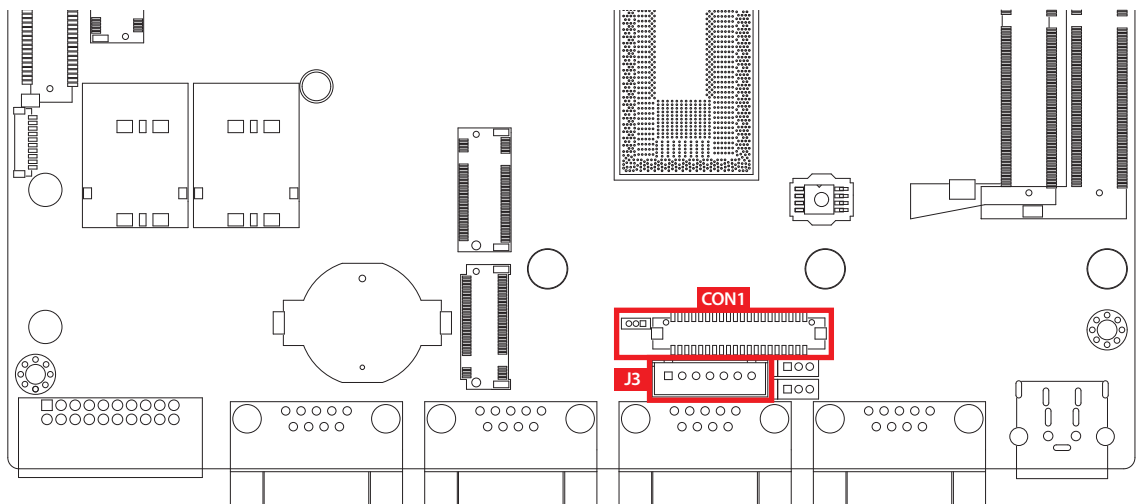

ABP-3000 supports dual-channel 24-bit LVDS display and up to 4096 x 2304 pixels resolution.

The pin assignments of LVDS are listed in the following table :

Pin No.	Function	Pin No.	Function
1	PANEL_VDD	21	GND
2	TXO0-	22	TXE0-
3	PANEL_VDD	23	GND
4	TXO0+	24	TXE0+
5	PANEL_VDD	25	GND
6	TXO1-	26	TXE1-
7	GND	27	GND
8	TXO1+	28	TXE1+
9	GND	29	GND
10	TXO2-	30	TXE2-
11	GND	31	GND
12	TXO2+	32	TXE2+
13	GND	33	GND
14	TXOC-	34	TXEC-
15	GND	35	GND
16	TXOC+	36	TXEC+
17	GND	37	GND
18	TXO3+-	38	TXE3-
19	GND	39	GND
20	TXO3+	40	TXE3+

The LCD inverter is connected to J3 via a JST 7-pin, 2.5mm connector providing +5V/+12V power to LCD display. The pin assignments are listed in the following table :

Pin No.	Definition	Pin No.	Definition
1	+5V	5	GND
2	+12V	6	GND
3	+12V	7	LBKLT_EN
4	LBKLT_CTL		

2.5 Main Jumper Settings

2.5.1 Front View of ABP-3000 Main Board with Jumper Location

The figure below is the top view of the ABP-3000 main board. It shows the location of the jumpers.

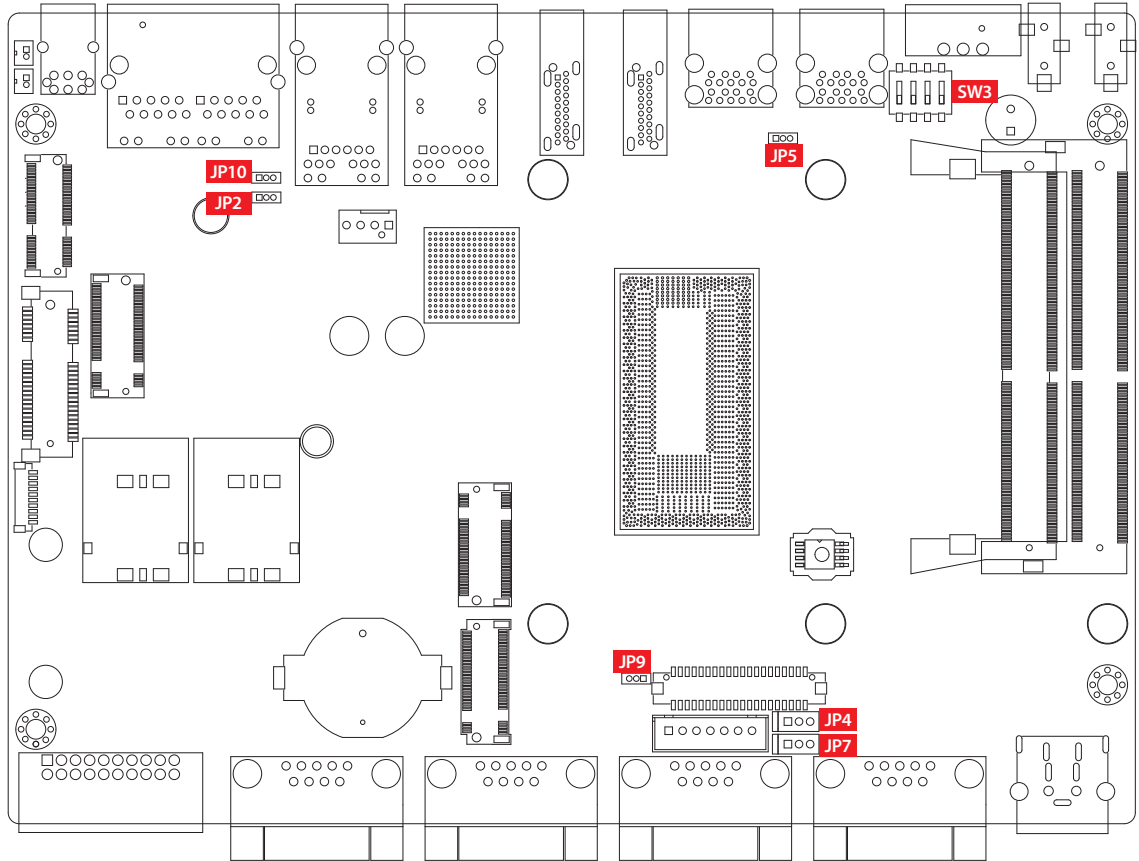

You may configure your card to match the needs of your application by setting jumpers. A jumper is a metal bridge used to close an electric circuit. It consists of two metal pins and a small metal clip (often protected by a plastic cover) that slides over the pins to connect them. To "close" a jumper, you connect the pins with the clip. To "open" a jumper, you remove the clip. Sometimes a jumper will have three pins, labeled 1, 2, and 3. In this case you would connect either pins 1 and 2, or 2 and 3.

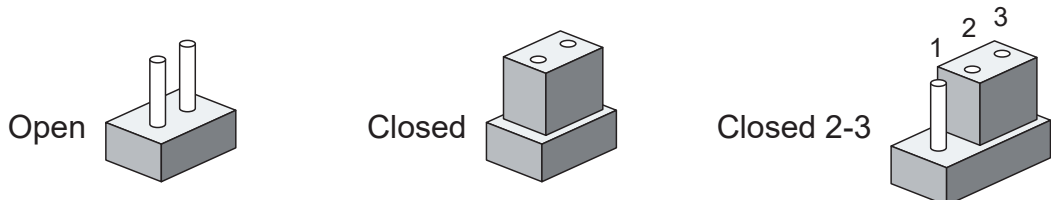

You may configure your card to match the needs of your application by DIP switch. As below show the DIP switch on and off.

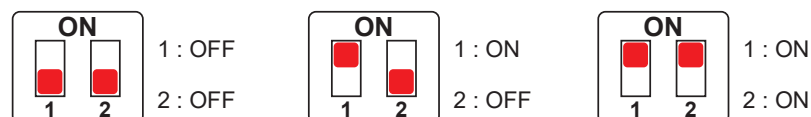

2.5.2 JP2 : Clear CMOS, JP10 : Clear ME

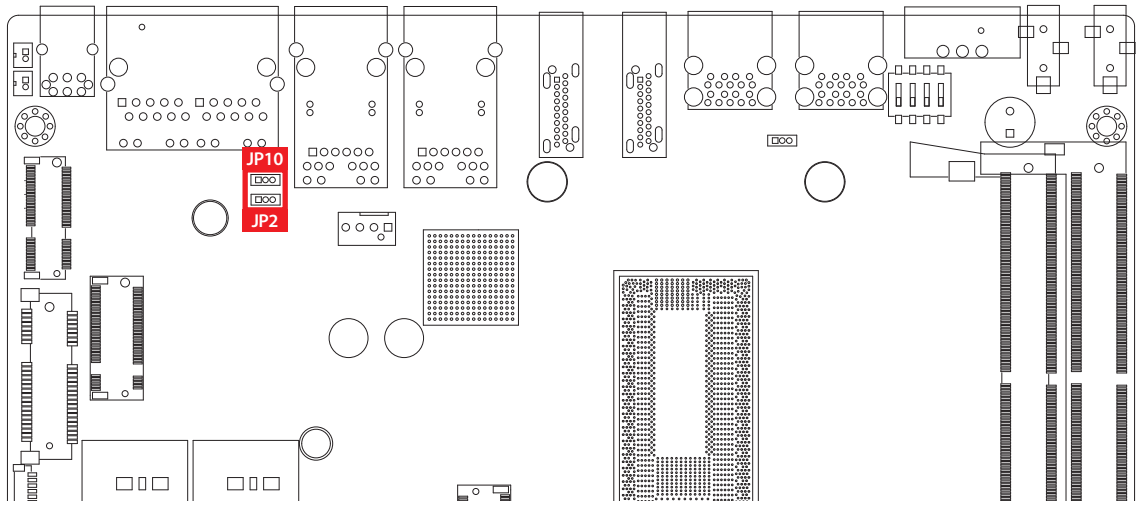

JP2

Pin No.	Definition
1-2	Normal
2-3	Clear CMOS

JP10

Pin No.	Definition
1-2	Normal
2-3	Clear ME

2.5.3 JP5 : Power Selection for EXT and INT USB 3.1 Gen2/USB 2.0 Ports

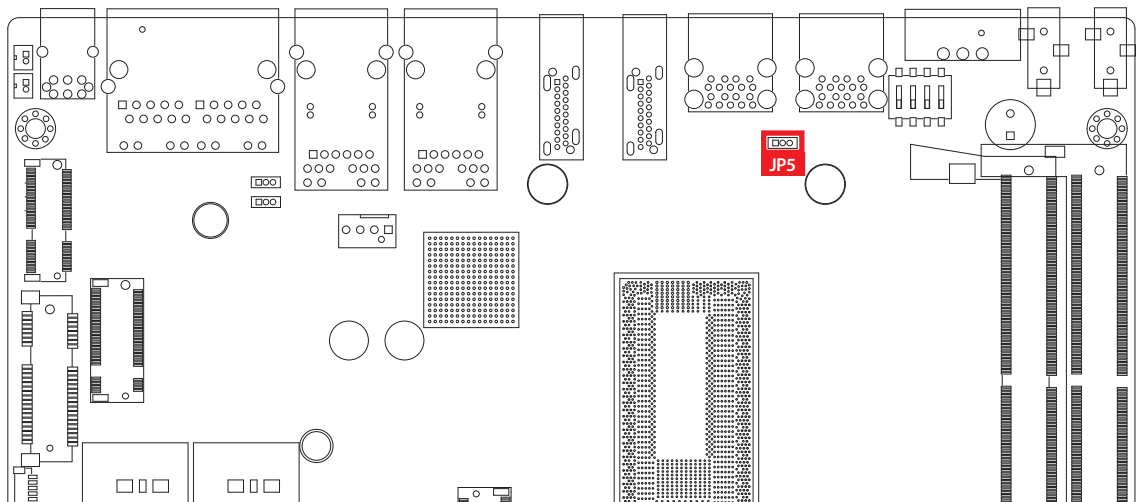

Pin No.	Power Source
1-2	+5V Standby Power
2-3	+5V System Power

2.5.4 JP9 : Backlight Control Level Selection

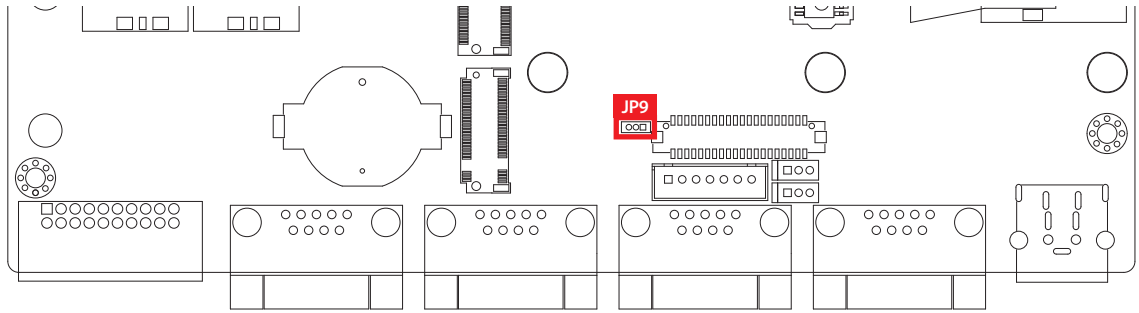

Pin No.	Power Source
1-2	3.3V
2-3	5V

2.5.5 JP4 : Power Selection for LVDS Module

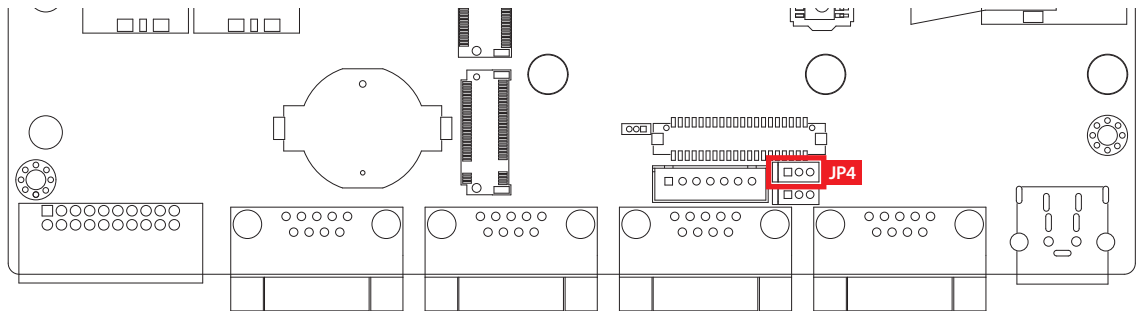

JP4 provides LVDS voltage selection function, Closing Pin 1 and Pin 2 is for 3.3V LVDS power input; closing Pin 2 and Pin 3 is for 5V LVDS power input.

Pin No.	Power Source
1-2	+3.3V (Default)
2-3	+5V

2.5.6 JP7 : PoE Power ON Select

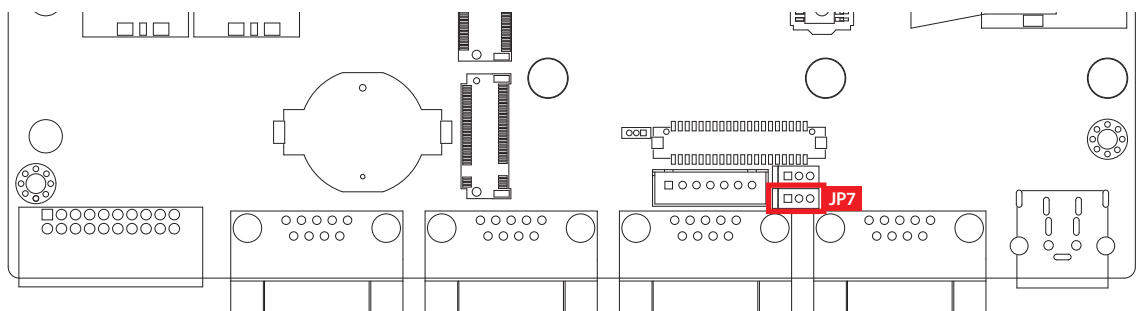

Pin No.	Power Source
1-2	PoE power on at standby power ready
2-3	PoE power on after system power on (Default)

2.6 Ignition Control



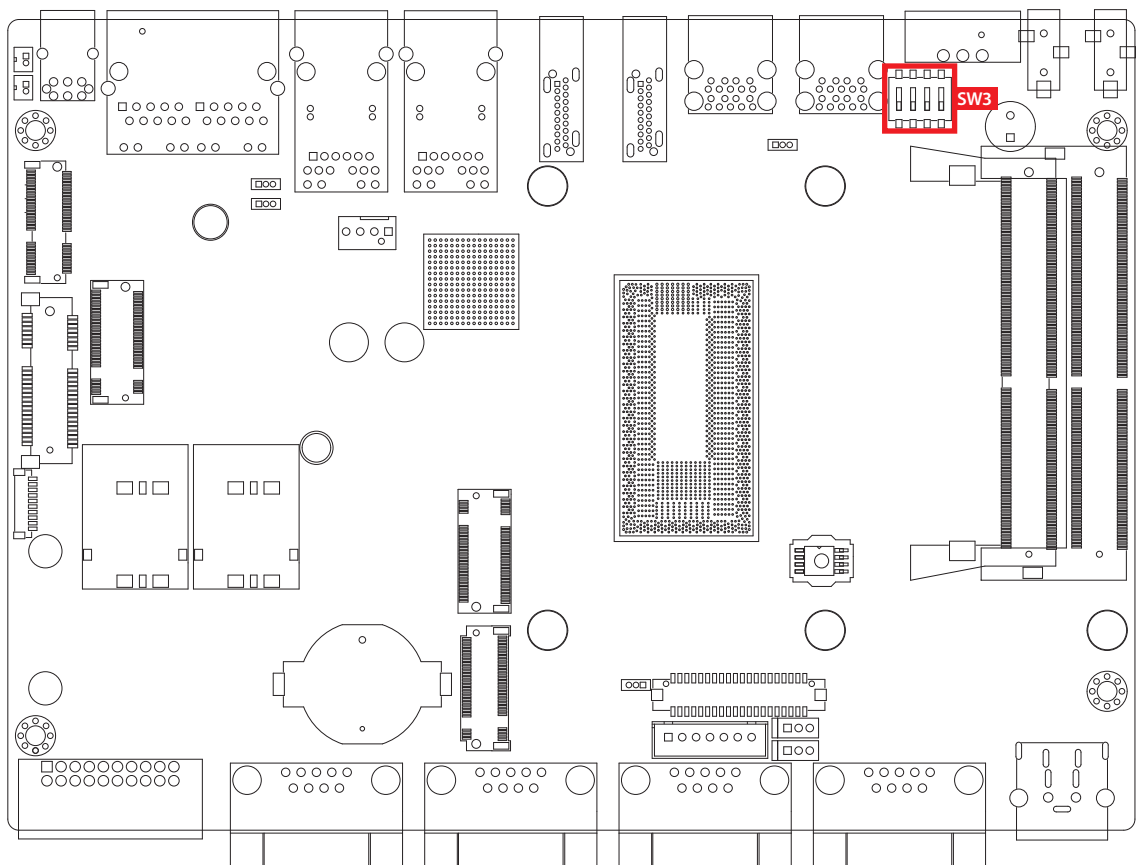

ABP-3000 series provides ignition power control feature for in-vehicle applications. The built-in MCU monitors the ignition signal and turns on/off the system according to pre-defined on/off delay period.

2.6.1 Adjust Ignition Control Modes

ABP-3000 series provides 16 modes of different power on/off delay periods adjustable via SW3 switch. The default rotary switch is set to 0 in ATX/AT power mode.

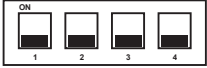

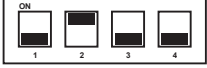
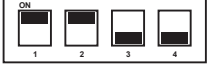
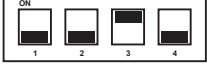
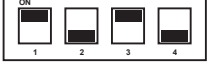
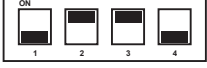
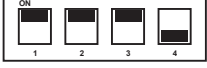
The modes are listed in below table :

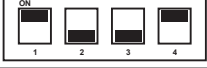
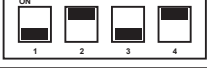
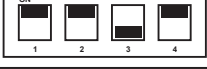
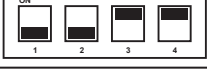
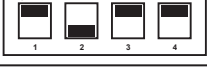
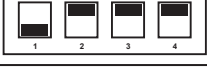
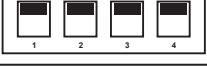
DIP Switch Position	Power on delay	Power off delay	Switch Position
0	ATX/AT mode (Default)		
1	No delay	No delay	
2	No delay	5 seconds	
3	No delay	10 seconds	
4	No delay	20 seconds	
5	5 seconds	30 seconds	
6	5 seconds	60 seconds	
7	5 seconds	90 seconds	
8	5 seconds	30 minutes	
9	5 seconds	1 hour	
A	10 seconds	2 hours	
B	10 seconds	4 hours	
C	10 seconds	6 hours	
D	10 seconds	8 hours	
E	10 seconds	12 hours	
F	10 seconds	24 hours	

2.6.2 Ignition Control Wiring

To activate ignition control, you need to provide IGN signal via the 3-pin pluggable terminal block locates in the back panel. It is below the general wiring configuration.

Pin No.	Definition
1	Ignition (IGN)
2	SW+
3	SW-

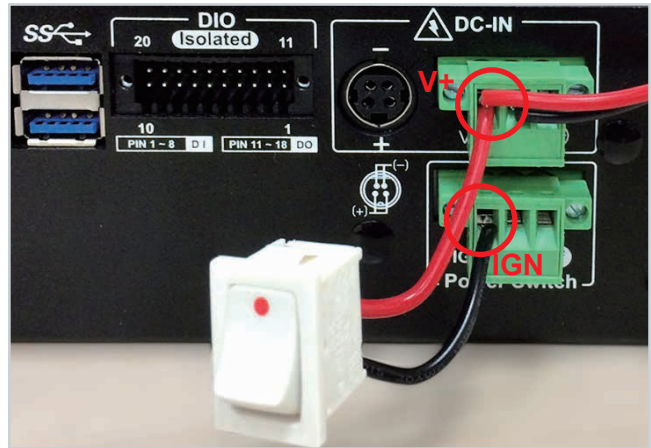

For testing purposes, you can refer to the picture below to simulate ignition signal input controlled by a latching switch.

Note :

1. DC power source and IGN share the same ground.
2. ABP-3000 supports 9V to 50V wide range DC power input in ATX/AT mode. In Ignition mode, the input voltage is fixed to 12V/24V for car battery scenario.
3. For proper ignition control, the power button setting should be "Power Down" mode.

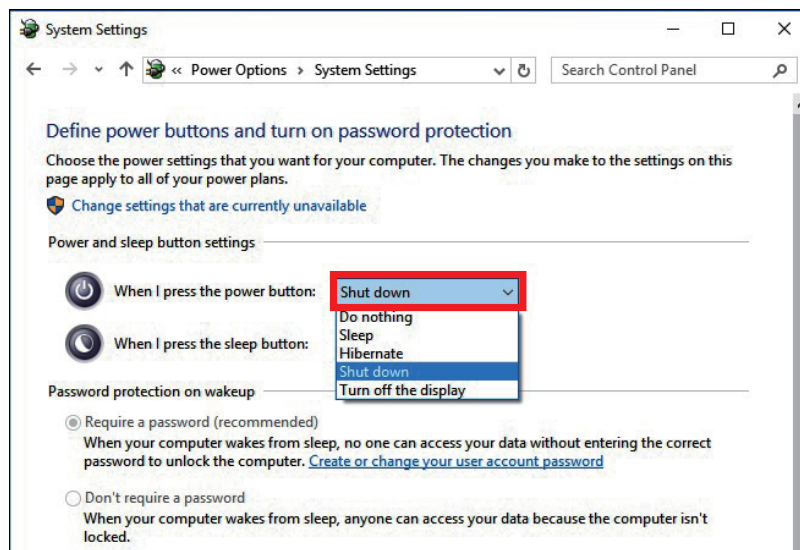

In Windows for example, you need to set "When I press the power button" to Shut down.

3

SYSTEM SETUP

3.1 How to Open Your ABP-3000

Step 1 Remove two Flat M3 screws. (ABP-3000 right side)

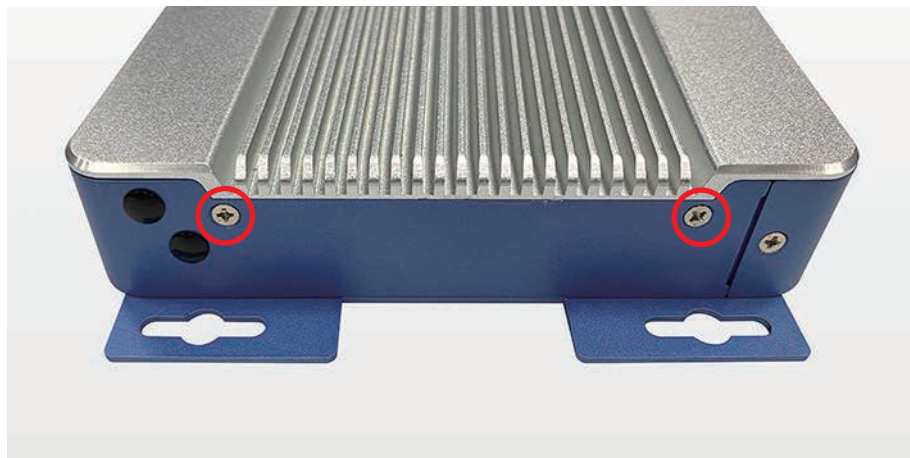

Step 2 Remove two Flat M3 screws. (ABP-3000 left side)

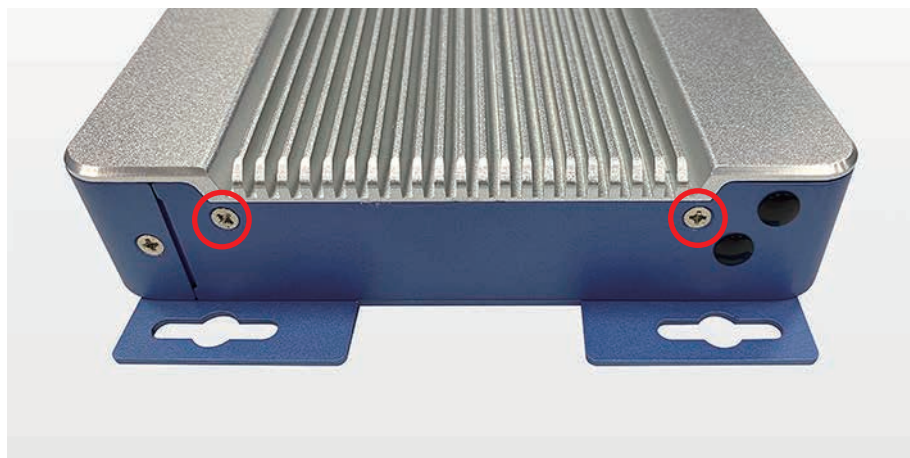

Step 3 Take out the heat sink.



Step 4 Finish STEP 1~3.



3.2 Installing DDR4 SO-DIMM Modules

Step 1 DDR4 SO-DIMM slot.

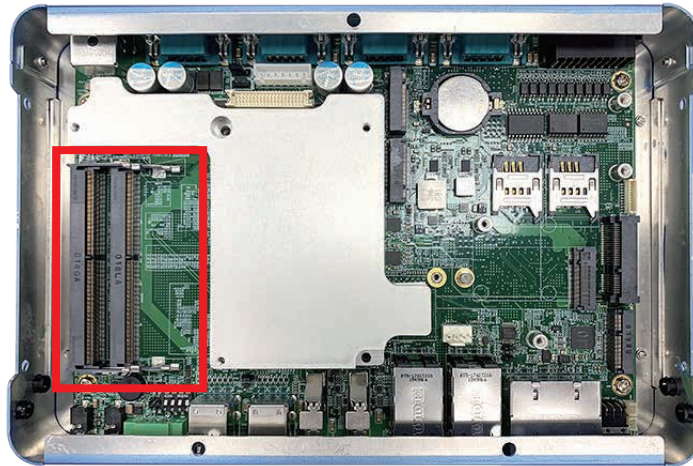

Step 2 Install DDR4 RAM module into SO-DIMM slot.

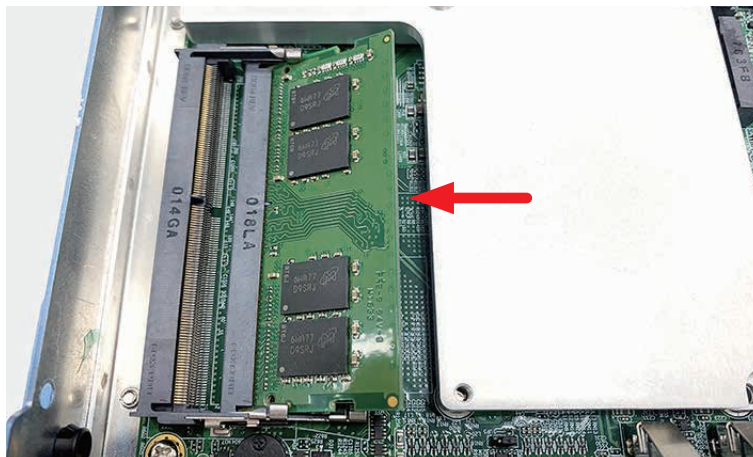

Step 3 Make sure the RAM module is locked by the memory slots.

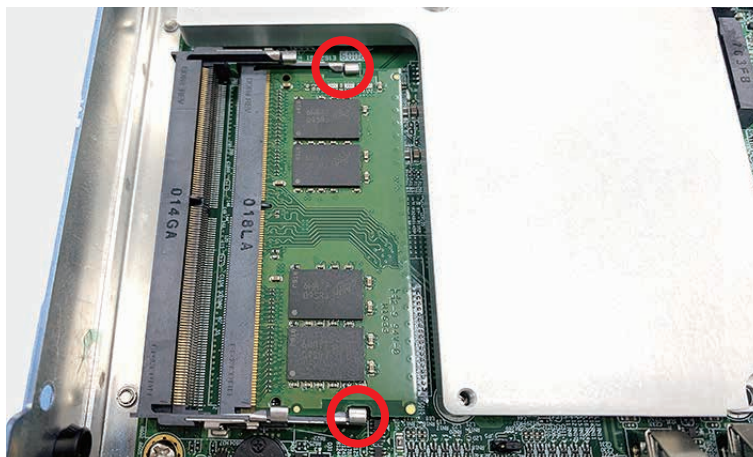

3.3 Installing Mini PCIe Card

Step 1 Mini PCIe slot.

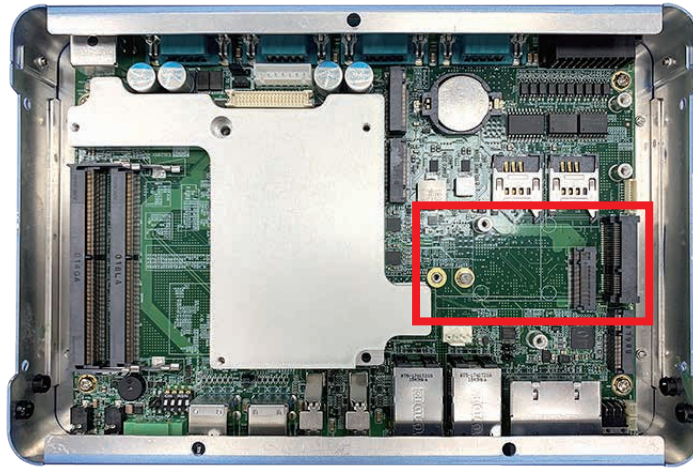

Step 2 Install Mini PCIe card into the Mini PCIe slot.

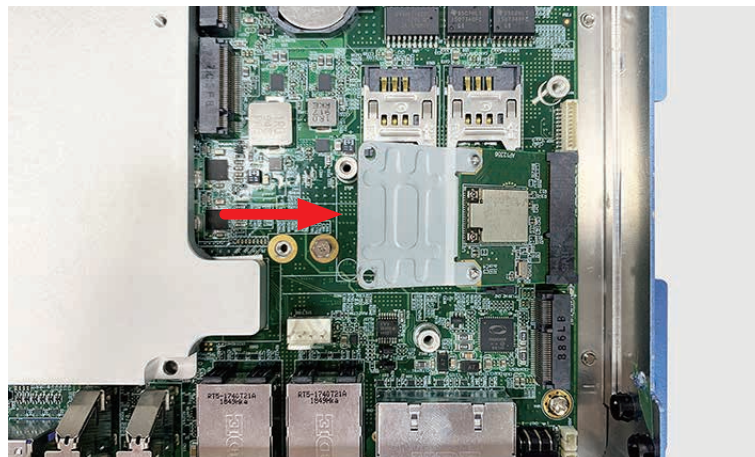

Step 3 Fasten one M2.5 screw.

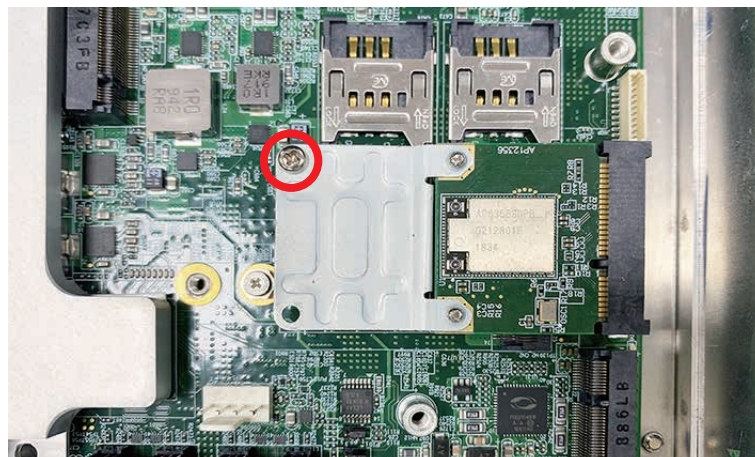

3.4 Installing M.2

3.4.1 Key E 2230, Key B 2280, Key M 2280

Step 1 Install M.2 card into the M.2 slot.



Step 2 Fasten one M3x6L screw.



3.4.2 Key B 3042

Step 1 Install M.2 card into the M.2 slot.

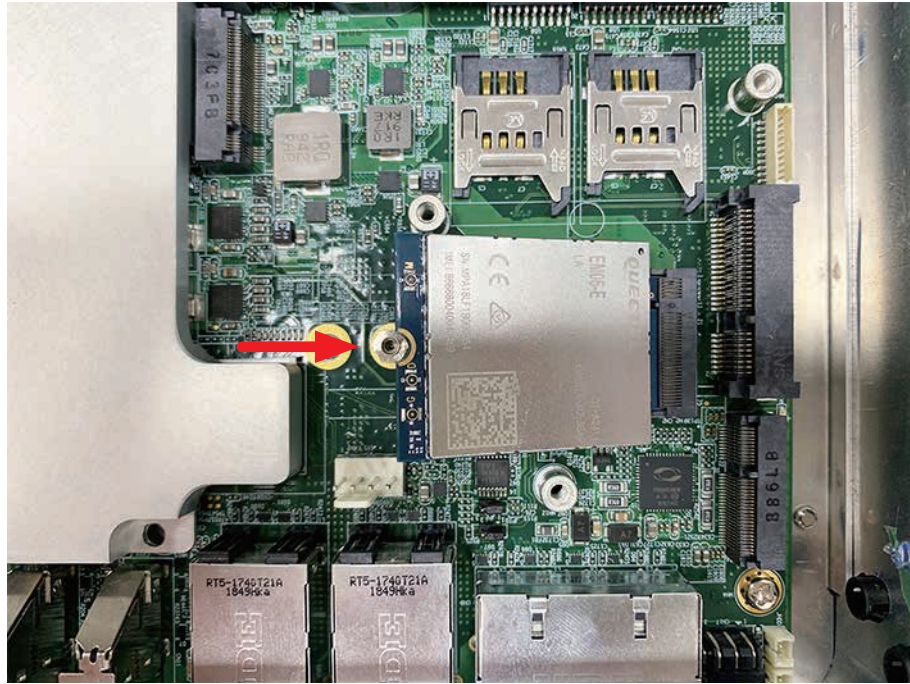

Step 2 Fasten one M2x2L screw.

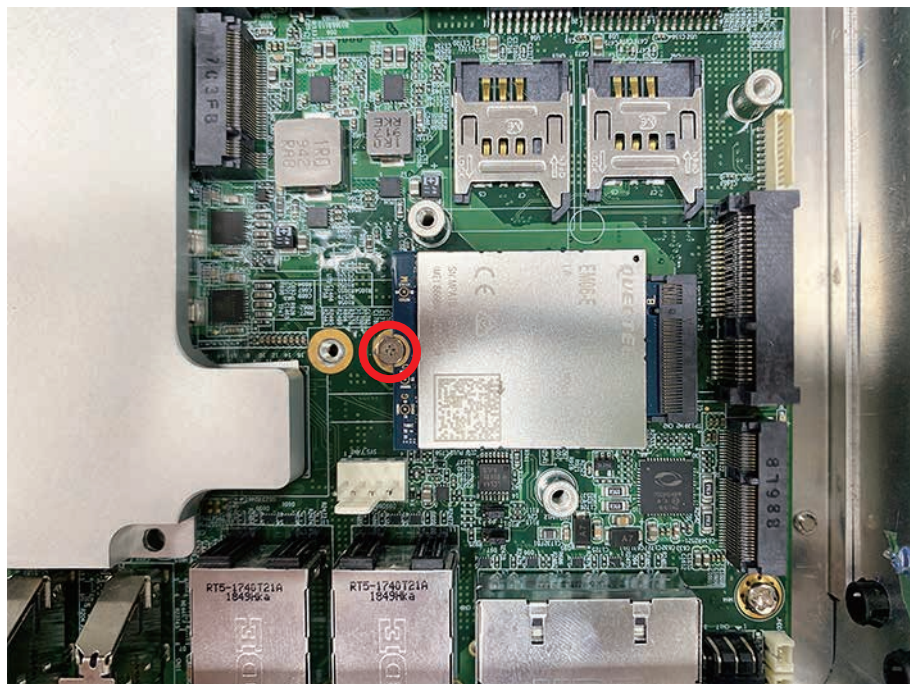

3.4.3 Key B 3052

Step 1 Change the stud position.

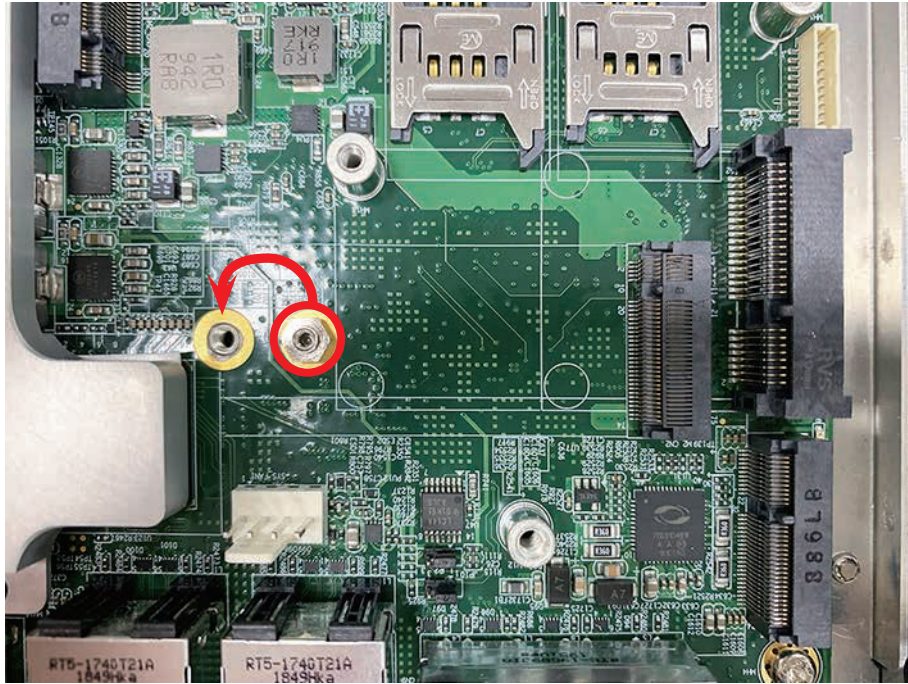

Step 2 Then, it is able to install M2 Key B 3052 module.

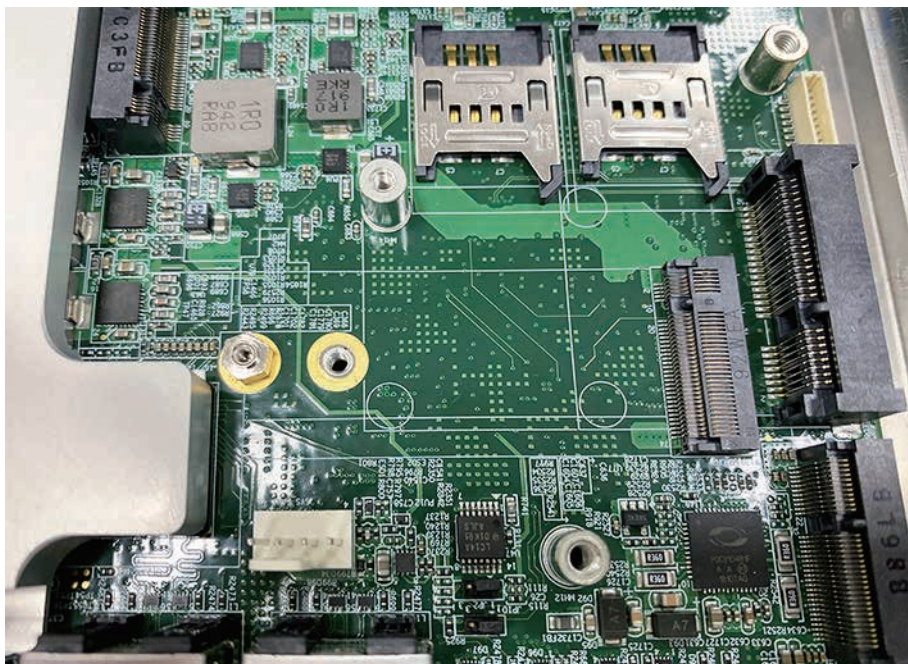

Step 3 Install M.2 card into the M.2 slot.

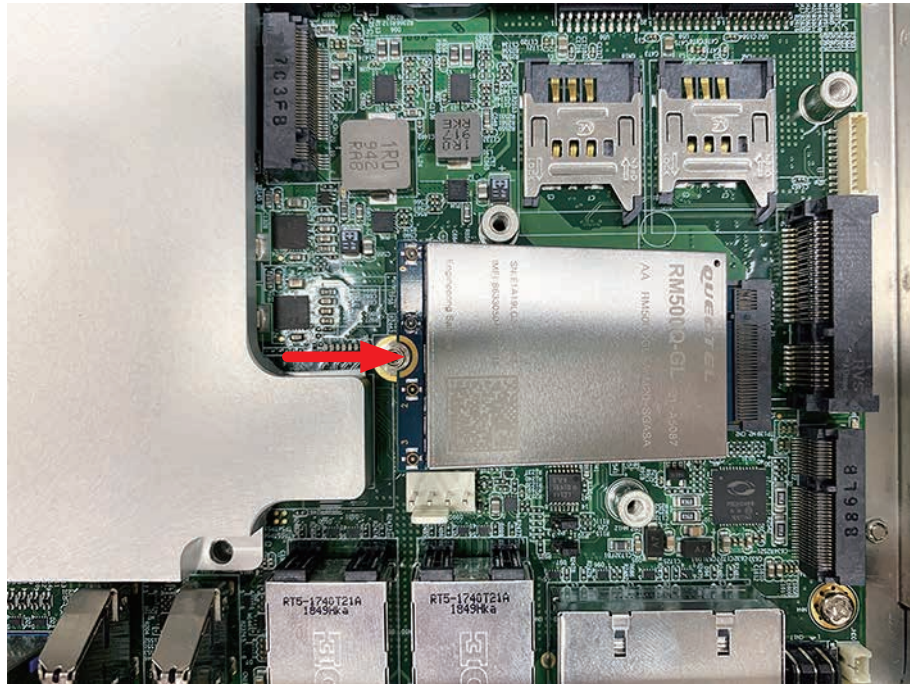

Step 4 Fasten one M2x2L screw.

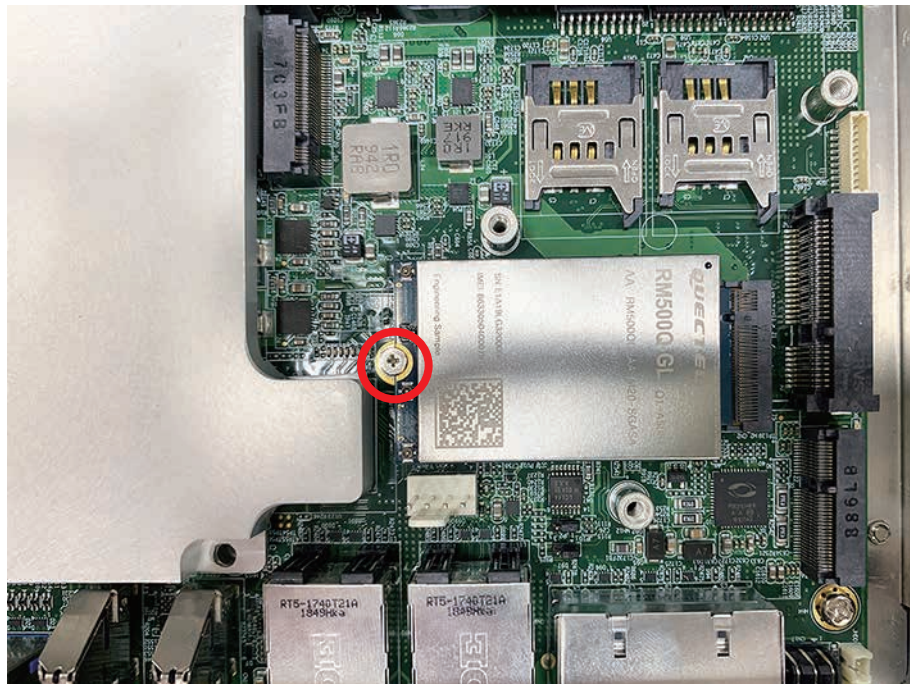

3.5 Installing Antenna Cable

Step 1 Remove rubber cork from the panel.

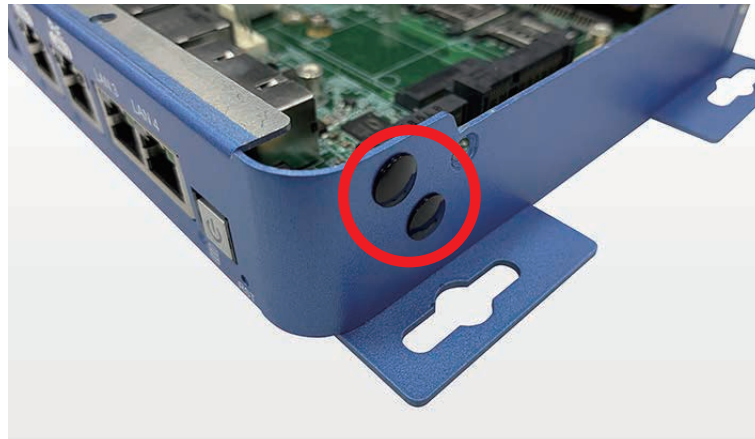

Step 2 Check antenna parts (cable and washers).

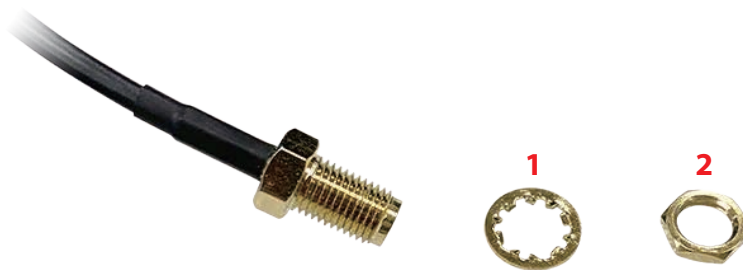

Step 3 Fasten washer 1, washer 2 and on Antenna cable connector.

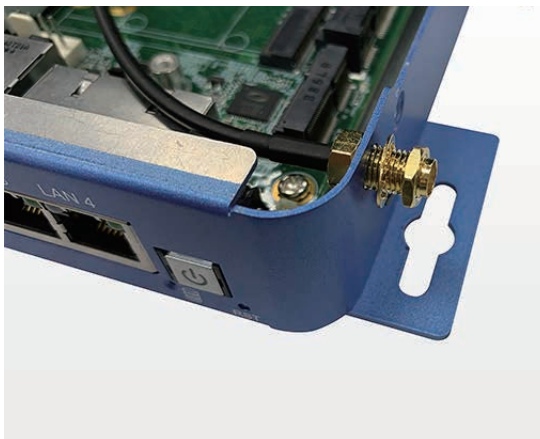

Step 4 Finish STEP 1~3.

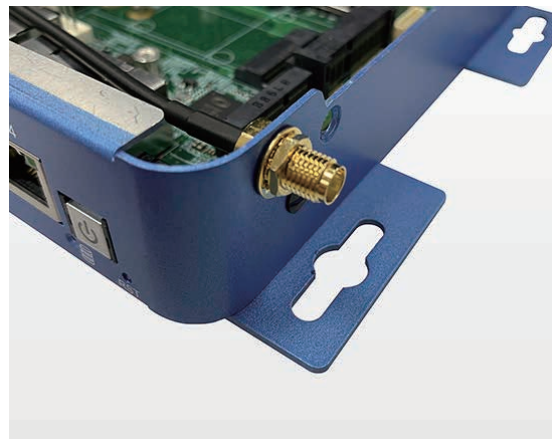

3.6 Installing SIM Card

Step 1 Push SIM card slot cover open and install SIM card.

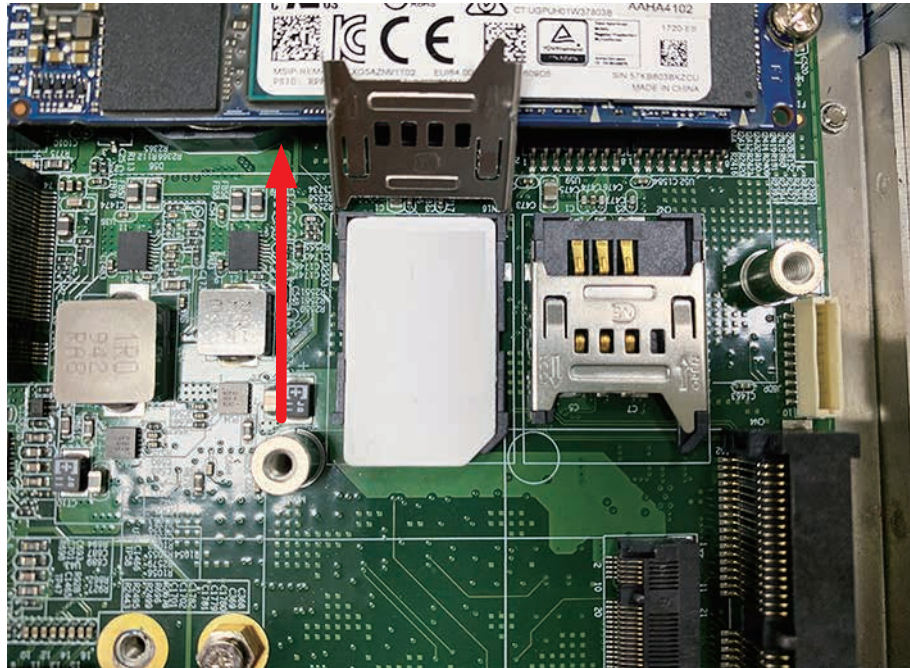

Step 2 Close the cover.

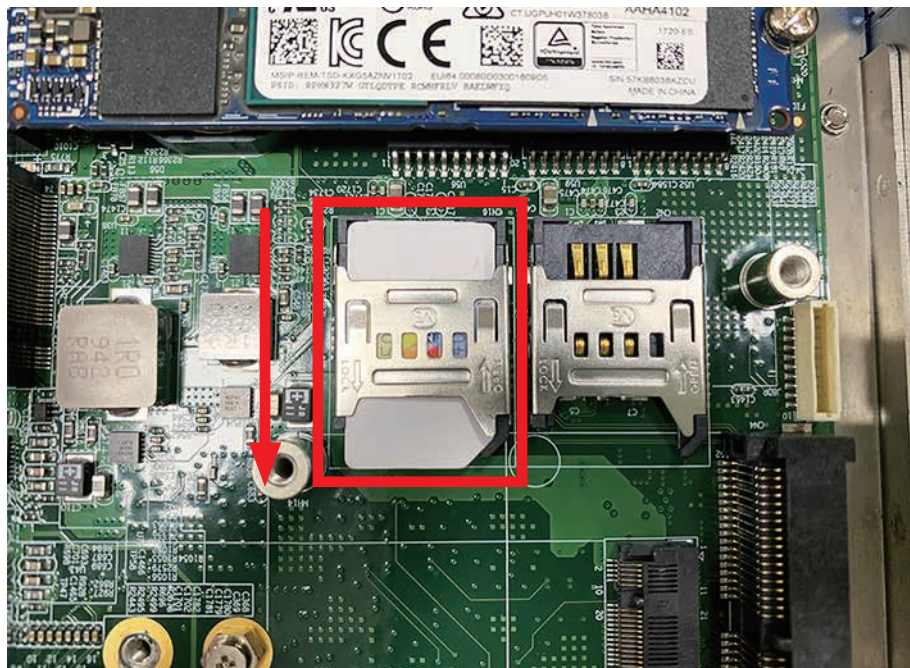

3.7 Mount Your ABP-3000

Step 1 Install wall mount to ABP-3000.



Step 2 Fasten four Flat M3x4L screws.



4

BIOS SETUP

4.1 BIOS Setting

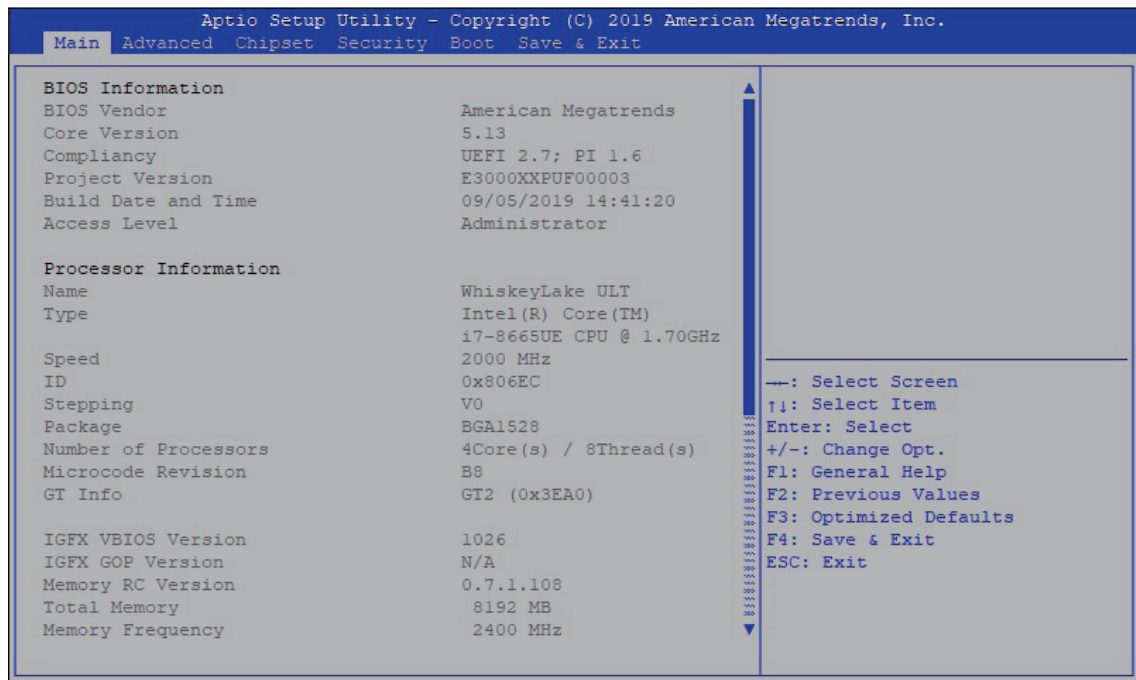

Figure 4-1 : Entering Setup Screen

BIOS provide an interface for user to check and change system configuration. The BIOS setup program is accessed by pressing the key when POST display output then main BIOS Setup menu screen is displayed.

4.2 Main Menu

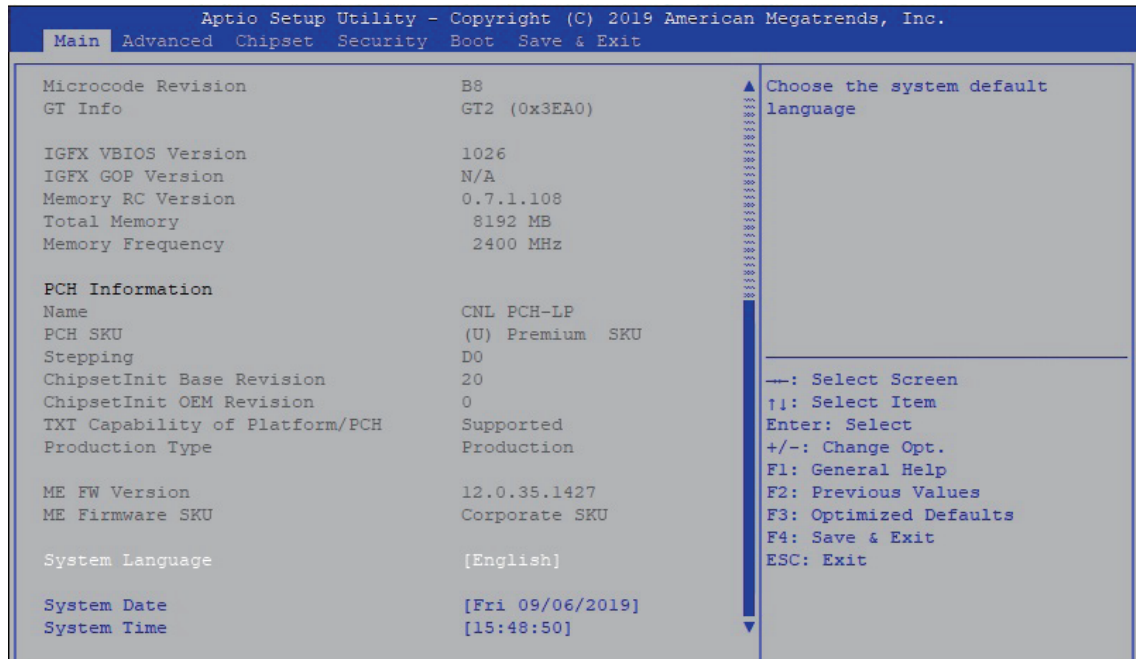

Figure 4-2 : BIOS Main Menu

The Main menu display BIOS version and system information. There are two options on Main menu.

System Date

Set the Date. Use Tab to switch between Date elements.

System Time

Set the Time. Use Tab to switch between Time elements.

4.3 Advanced Functions

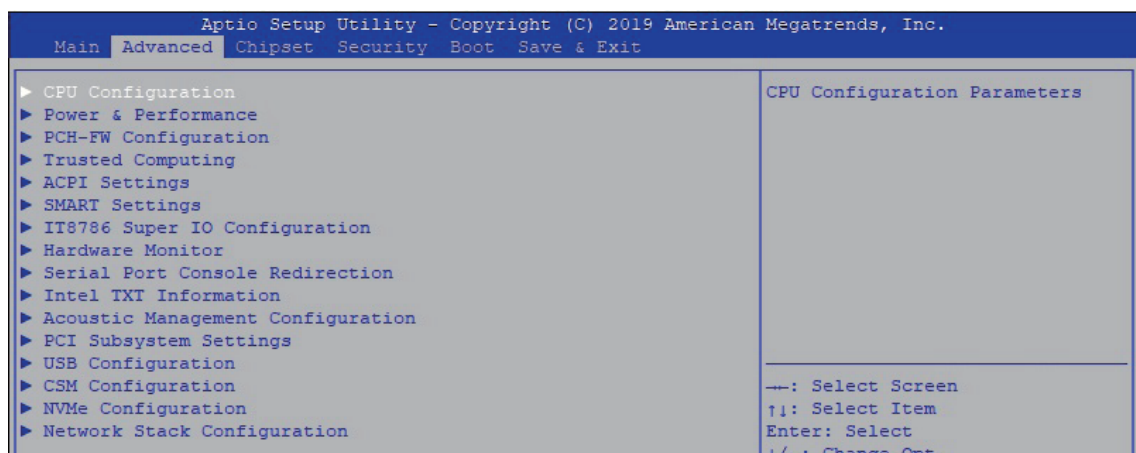

Figure 4-3 : BIOS Advanced Menu

Select Advanced tab to enter advanced BIOS Setup options such as CPU Configuration, SATA Configuration and USB Configuration.

4.3.1 CPU Configuration

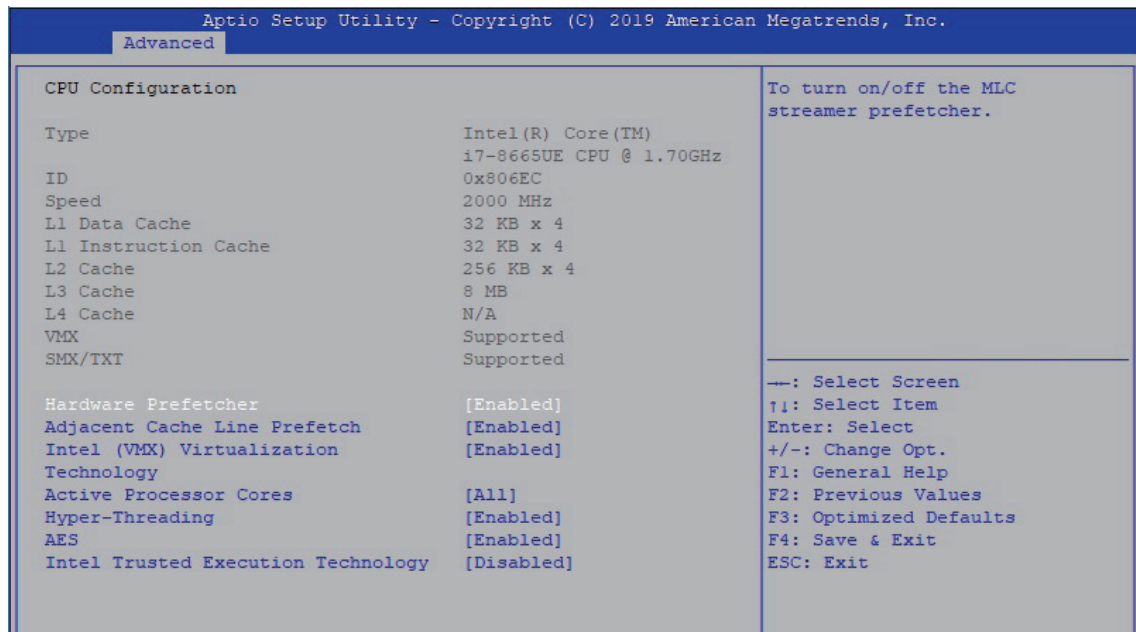

Figure 4-3-1 : CPU Configuration

Display CPU related information and features supported.

Hardware Prefetcher

To turn on/off the MLC streamer prefetcher.

Adjacent Cache Line Prefetch

To turn on/off prefetching of adjacent cache lines.

Intel (VMX) Virtualization Technology

When enabled, a VMM can utilize the additional hardware capabilities provided by Vanderpool Technology.

Active Processor Cores

Number of cores to enable in each processor package.

Hyper-threading

Enabled or Disabled Hyper-Threading Technology.

AES

Enable/Disable AES (Advanced Encryption Standard).

Intel Trusted Execution Technology

Enables utilization of additional hardware capabilities provided by Intel Trusted Execution Technology.

Changed require a full power cycle to take effect.

4.3.2 Power & Performance

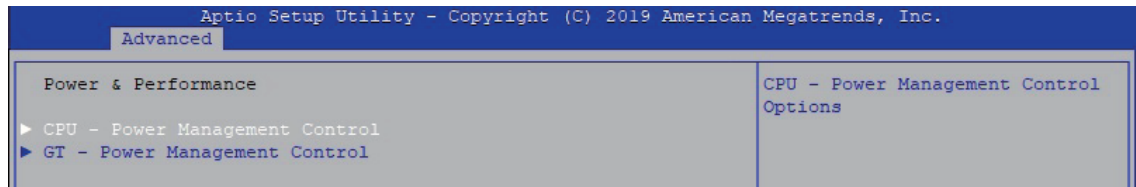

Figure 4-3-2 : Power & Performance

4.3.2.1 CPU - Power Management Control

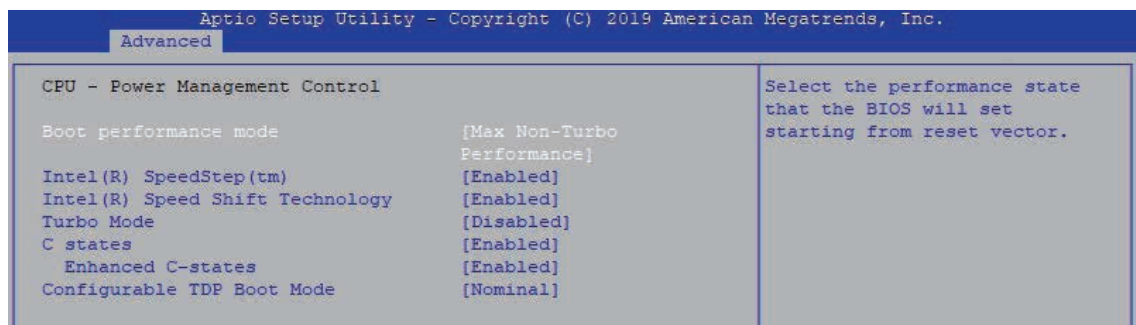

Figure 4-3-2-1 : CPU - Power Management Control

Boot performance mode

Select the performance state that the BIOS will set starting from reset vector.

Intel® SpeedStep™

Allow more than two frequency ranges to be supported.

Intel® Speed shift Technology

Enable/Disable Intel® Speed shift Technology support. Enabling will expose the CPPCv2 interface to allow for hardware controlled P-states.

Turbo Mode

Enable/Disable processor Turbo Mode (requires Intel Speed Step or Intel Speed Shift to be available and enabled).

C states

Enable or disable CPU Power management. Allows CPU to go to C states when it's no 100% utilized.

Enhanced C-states

Enable/disable C1E. When enabled, CPU will switch to minimum speed when all cores enter C-State.

Configurable TDP Boot Mode

Configurable TDP Mode as Nominal/Up/Down/Deactivate TDP selection. Deactivate option will set MSR to Nominal and MMIO to Zero. Configurable TDP allows operation in situation where extra cooling is available or situations where a cooler and quieter mode of operation is desired.

4.3.2.2 GT - Power Management Control

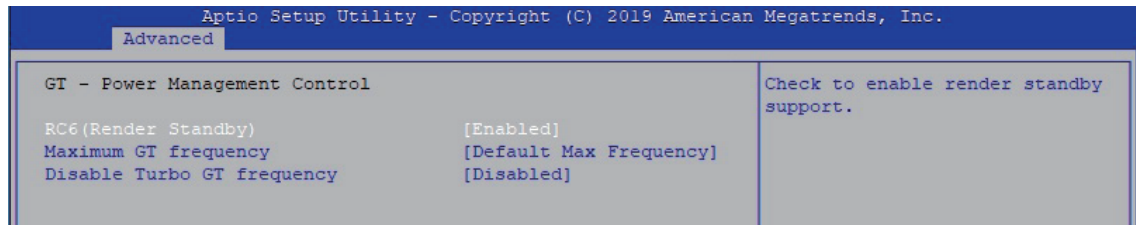

Figure 4-3-2-2 : GT - Power Management Control

RC6 (Render Standby)

Check to enable render standby support.

Maximum GT frequency

Maximum GT frequency limited by the user. Choose between 300MHz (RPN) and 1150 MHz (RP0). Value beyond the range will be clipped to min/max supported by SKU.

Disable Turbo GT frequency

Enabled : Disables Turbo GT frequency. Disabled : GT frequency is not limited.

4.3.3 PCH-FW Configuration

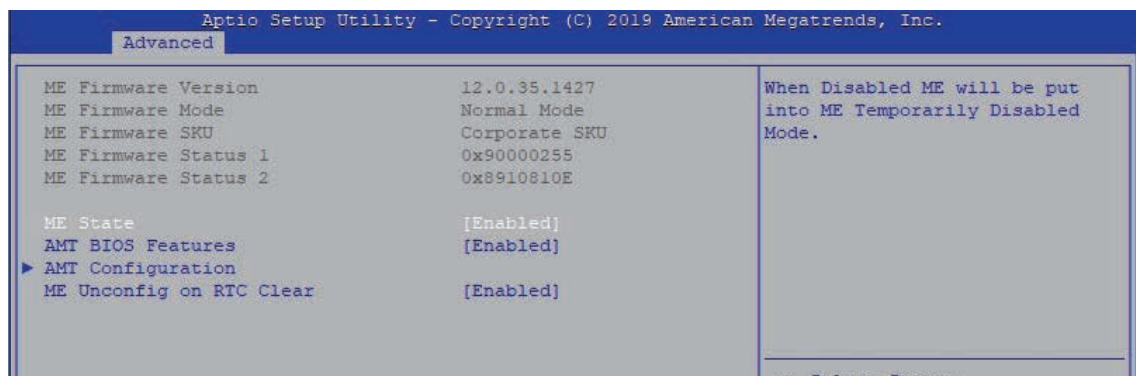

Figure 4-3-3 : PCH-FW Settings

ME State

When Disabled ME will be put into ME Temporarily Disabled Mode.

AMT BIOS Features

When disabled AMT BIOS Features are no longer supported and user is no longer able to access MEBx Setup. Note : This option does not disable Manageability Features in FW.

AMT Configuration

Configure Intel Active Management Technology Parameters.

ME Unconfig on RTC Clear

Disabling this option will cause ME not be unconfigured on RTC clear.

4.3.4 Trusted Computing

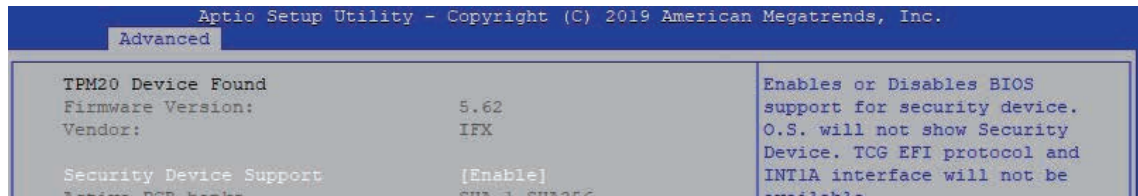

Figure 4-3-4 : Trusted Computing

Control the TPM device status and display related information if TPM chip is present.

4.3.5 ACPI Settings

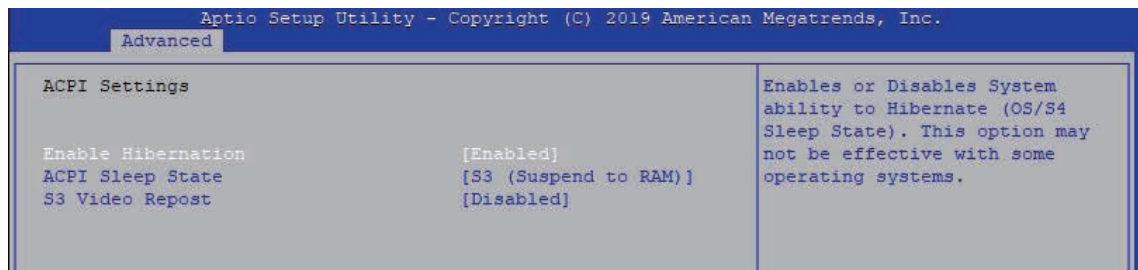

Figure 4-3-5 : ACPI Settings

Enable Hibernation :

Enables or Disables System ability to Hibernate (OS/S4 Sleep State). This option may be not effective with some OS.

ACPI Sleep State

Select the highest ACPI sleep state the system will enter when the SUSPEND button is pressed.

S3 Video Repost

Enable or Disable S3 Video Repost.

4.3.6 SMART Settings

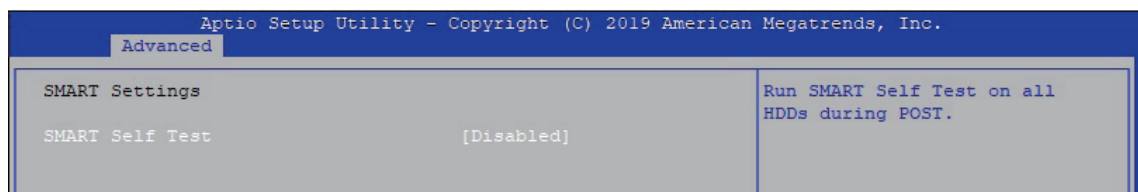

Figure 4-3-6 : SMART Settings

SMART Self Test

Run SMART Self-test on all HDDs during POST.

4.3.7 IT8786 Super IO Configuration

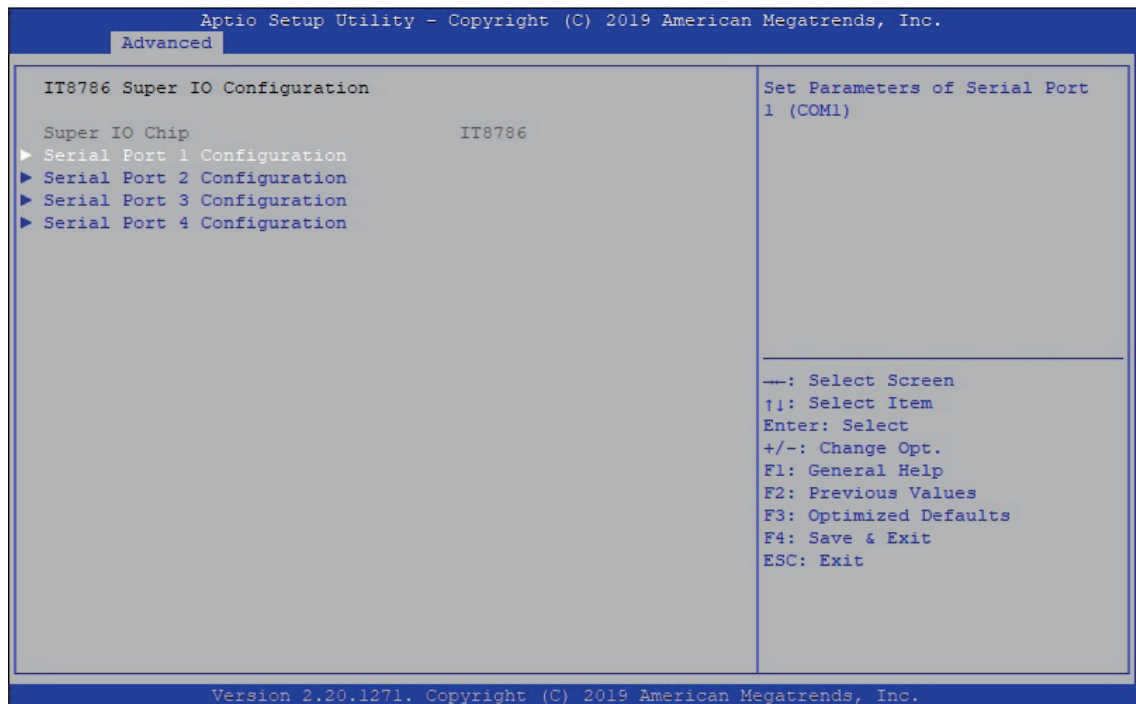

Figure 4-3-7 : Super IO Settings

Serial Port 1 Configuration

Set Parameters of Serial Port 1 (COM1).

Serial Port 2 Configuration

Set Parameters of Serial Port 2 (COM2).

Serial Port 3 Configuration

Set Parameters of Serial Port 3 (COM3).

Serial Port 4 Configuration

Set Parameters of Serial Port 4 (COM4).

4.3.8 Hardware Monitor

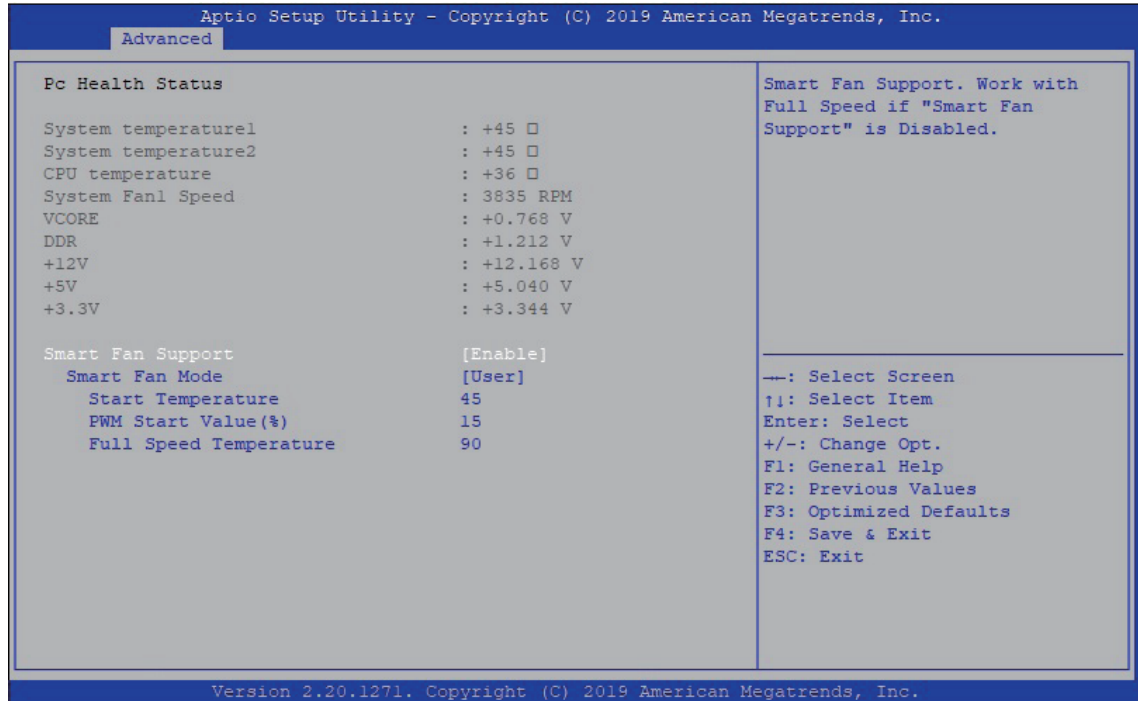

Figure 4-3-8 : Hardware Monitor Settings

The IT8786 SIO features an enhanced hardware monitor providing thermal, fan speed and system voltages status monitoring.

Smart Fan Support

Smart Fan Support. Work with full Speed if "Smart Fan Support" is Disabled.

Smart Fan Mode

Default : Using the default smart fan table.
User : Setting parameters by user.

Start Temperature

Temperature Limit value of Fan Start (Degree C).
(Range : 10-80)

PWM Start Value (%)

Default PWM Value of Fan.
(Range : 15%-100%)

Full Speed Temperature

Temperature Limit value of Fan Full Speed (Degree C).
(Range : 50-90)

4.3.9 Serial Port Console Redirection

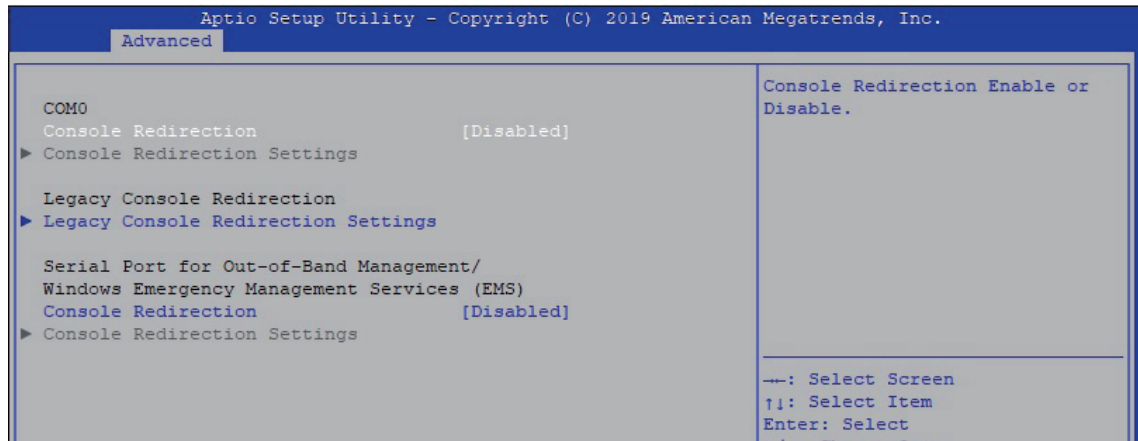

Figure 4-3-9 : Serial Port Console Redirection Settings

Console Redirection

Console Redirection Enable or Disable.

Console Redirection Settings

The settings specify how the host computer and the remote computer (which the user is using) will exchange data. Both computers should have the same or compatible settings.

Legacy Console Redirection Settings

Legacy Console Redirection Settings

Serial Port for Out-of-Band management/Windows Emergency Management Services (EMS)

Console Redirection Enable or Disable.

4.3.10 Intel TXT Information

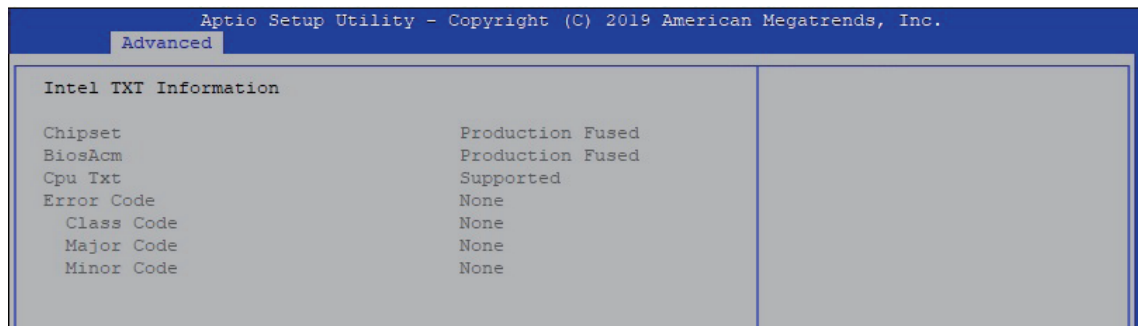

Figure 4-3-10 : Intel TXT Information

Display Intel TXT information.

4.3.11 Acoustic Management Configuration

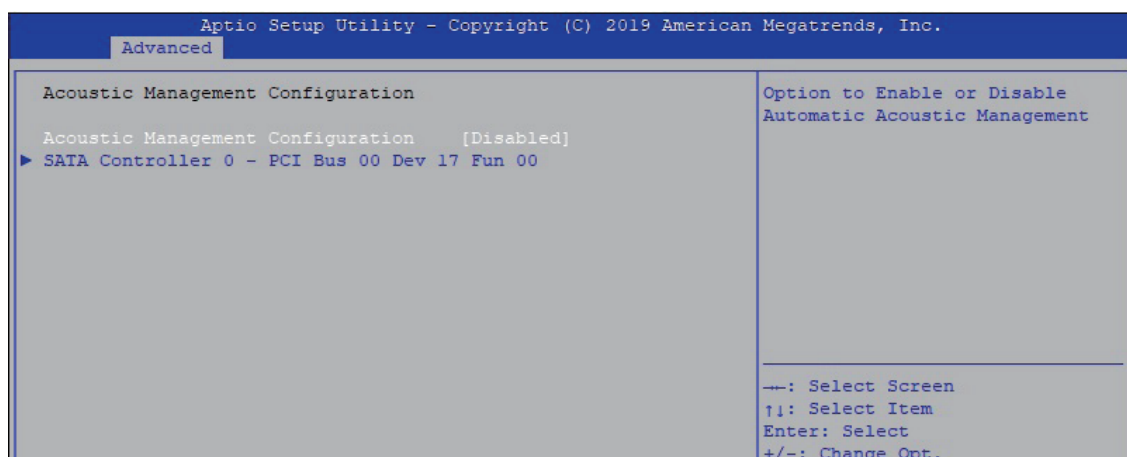

Figure 4-3-11 : Acoustic Management Settings

Acoustic Management Configuration

Option to Enable or Disable Automatic Acoustic Management.

4.3.12 PCI Subsystem Settings

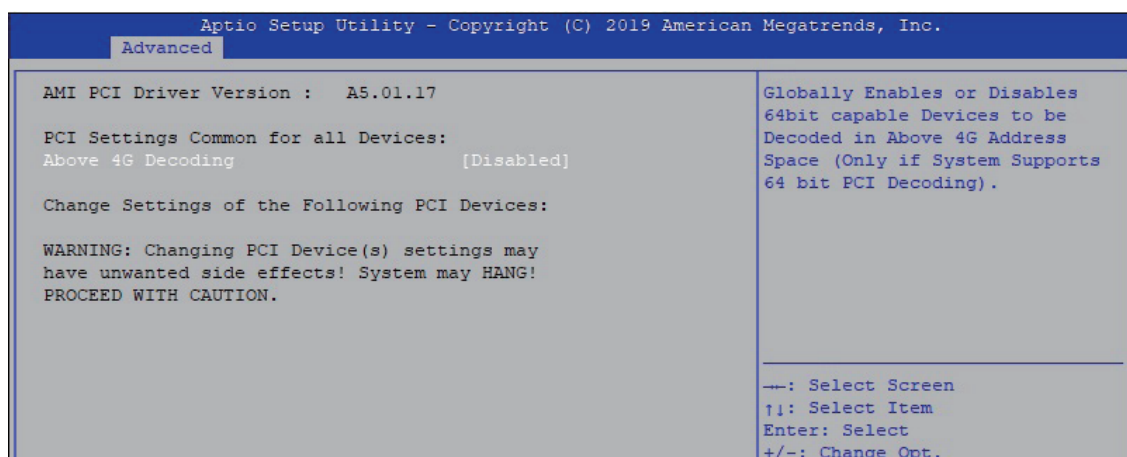

Figure 4-3-12 : PCI Subsystem Settings

Above 4G Decoding

Globally Enables or Disables 64bit capable Devices to be Decoded in Above 4G Address Space (Only if System Supports 64 bit PCI Decoding).

4.3.13 USB Configuration

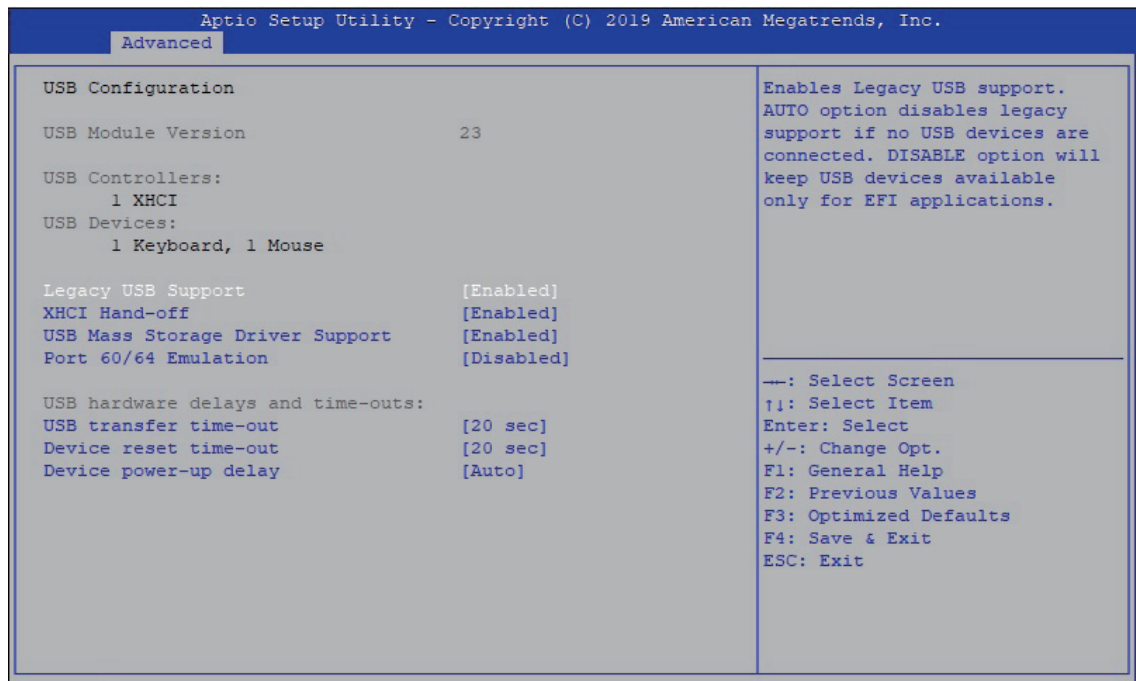

Figure 4-3-13 : USB Settings

Legacy USB Support

Enables Legacy USB support.

AUTO option disables legacy support if no USB devices are connected. ISABLE option will keep USB devices available only for EFI applications.

XHCI Hand-off

This is a workaround for Oses without XHCI hand-off support. The XHCI ownership change should be claimed by XHCI driver.

USB Mass Storage Driver Support

Enable/Disable USB Mass Storage Driver Support.

Port 60/64 Emulation

Enables I/O port 60h/64h emulation support. This should be enabled for the complete USB keyboard legacy support for non-USB aware Oses.

USB transfer time-out

The time-out value for Control, Bulk, and Interrupt transfers.

Device reset time-out

USB mass storage device Start Unit command time-out.

Device power-up delay

Maximum time the device will take before it properly reports itself to the Host Controller. 'Auto' uses default value : for a Root port it is 100 ms, for a Hub port the delay is taken from Hub descriptor.

4.3.14 CSM Configuration

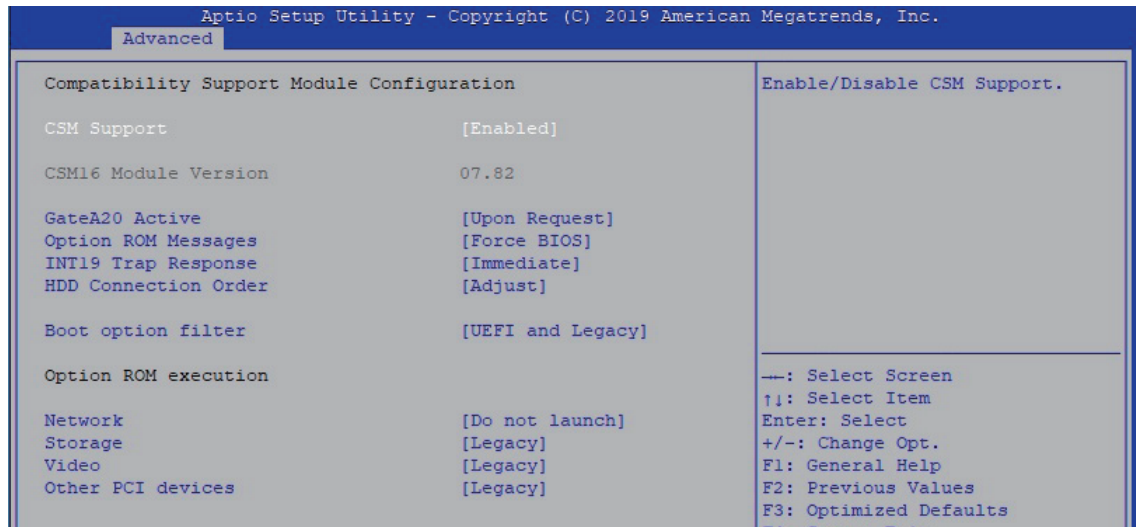

Figure 4-3-14 : CSM Settings

CSM Support

Enable/Disable CSM Support.

GateA20 Active

UPON REQUEST - GA20 can be disabled using BIOS services.

ALWAYS - do not allow disabling GA20; this option is useful when any RT code is executed above 1MB.

Option ROM Messages

Set display mode for Option ROM.

INT19 Trap Response

BIOS reaction on INT19 trapping by Option ROM :

IMMEDIATE - execute the trap right away;

POSTPONED - execute the trap during legacy boot.

HDD Connection Order

Some OS require HDD handles to be adjusted, i.e. OS is installed on drive 80h.

Boot option filter

This option controls Legacy/UEFI ROMs priority.

Network

Controls the execution of UEFI and Legacy PXE OpROM.

Storage

Controls the execution of UEFI and Legacy Storage OpROM.

Video

Controls the execution of UEFI and Legacy Video OpROM.

Other PCI devices

Determines OpROM execution policy for devices other than Network, Storage, or Video.

4.3.15 NVMe Configuration

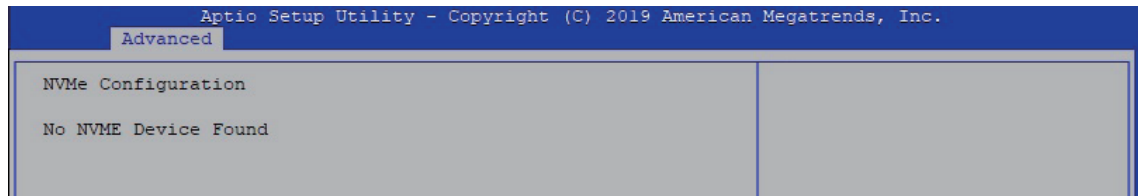

Figure 4-3-15 : NVMe Configuration

Display NVMe Controller and drive information.

4.3.16 Network Stack Configuration

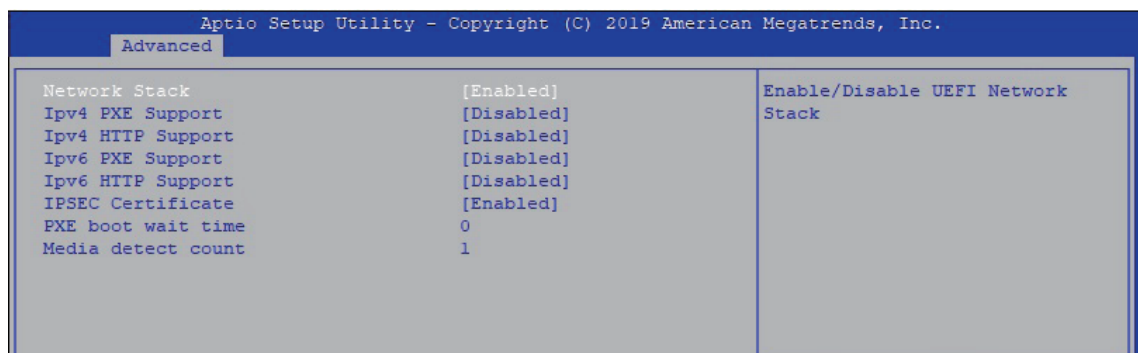

Figure 4-3-16 : Network Stack Settings

Network Stack

Enable/Disable UEFI Network Stack.

Ipv4 PXE Support

Enable/disable IPv4 PXE boot support.

Ipv4 HTTP Support

Enable/disable IPv4 HTTP boot support.

Ipv6 PXE Support

Enable/disable IPv6 PXE boot support.

Ipv6 HTTP Support

Enable/disable IPv6 HTTP boot support.

IPSEC Certificate

Support to Enable/disable IPSEC certificate for Ikev.

PXE boot wait time

Wait time to press ESC key to abort the PXE boot.

Media detect count

Number of times presence of media will be checked.

4.4 Chipset Functions

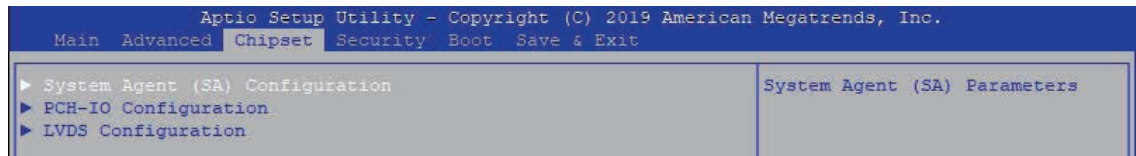

Figure 4-4 : BIOS Chipset Menu

System Agent (SA) Configuration

System Agent (SA) Parameters.

PCH-IO Configuration

PCH Parameters.

LVDS Configuration

LVDS Configuration.

4.4.1 System Agent (SA) Configuration

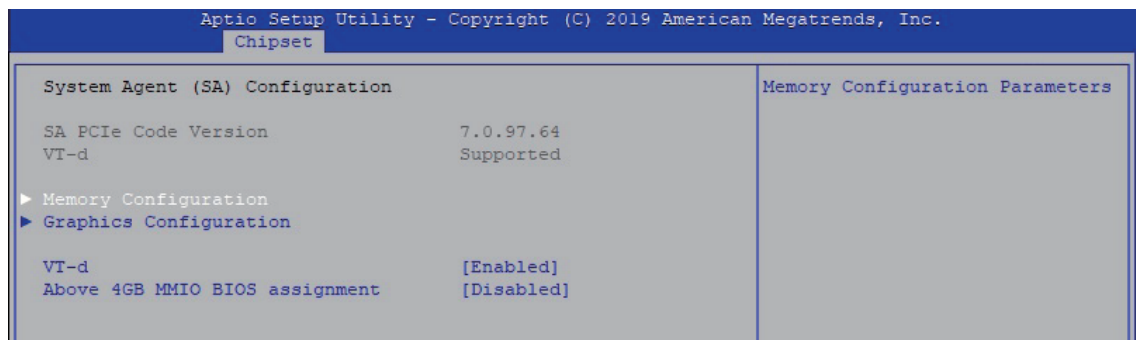

Figure 4-4-1 : System Agent Settings

VT-d

VT-d capability.

Above 4GB MMIO BIOS assignment

Enable/Disable above 4GB MemoryMappedIO BIOS assignment. This is disabled automatically when Aperture Size is set to 2048MB.

4.4.1.1 Memory Configuration

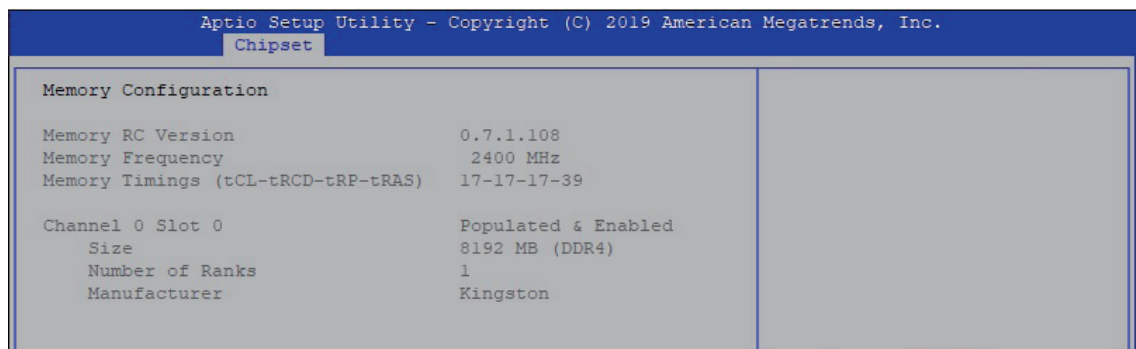

Figure 4-4-1-1 : Memory Information

Display memory information.

4.4.1.2 Graphics Configuration

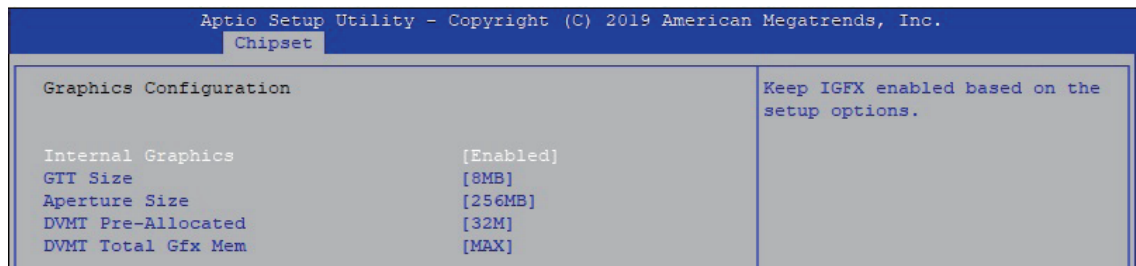

Figure 4-4-1-2 : Graphics Settings

Internal Graphics

Keep IGFX enabled based on the setup options.

GTT Size

Select the GTT size.

Aperture Size

Select the aperture size.

Note : Above 4GB MMIO BIOS assignment is automatically enabled when selecting 2048MB aperture. To use this feature, please disable CSM support.

DVMT Pre-Allocated

Select DVMT 5.0 pre-allocated (fixed) graphics memory size used by the internal graphics device.

DVMT Total Gfx Mem

Select DVMT 5.0 total graphic memory size used by the internal graphics device.

4.4.2 PCH-IO Configuration

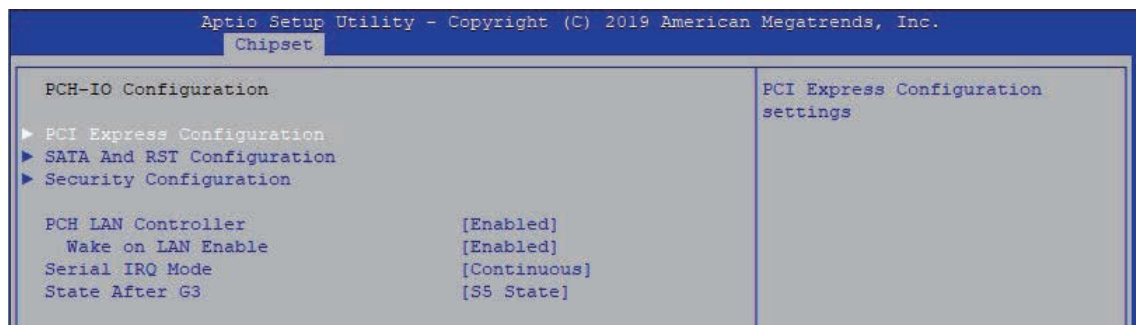

Figure 4-4-2 : PCH-IO Settings

PCH LAN Controller

Enable or disable onboard NIC.

Wake on LAN

Enable or disable integrated LAN to wake the system. (The Wake On LAN cannot be disabled if ME is on at Sx state.).

Serial IRQ Mode

Configure Serial IRQ Mode.

State After G3

Specify what state to go to when power is re-applied after a power failure (G3 state).

4.4.2.1 PCI Express Configuration of PCH-IO

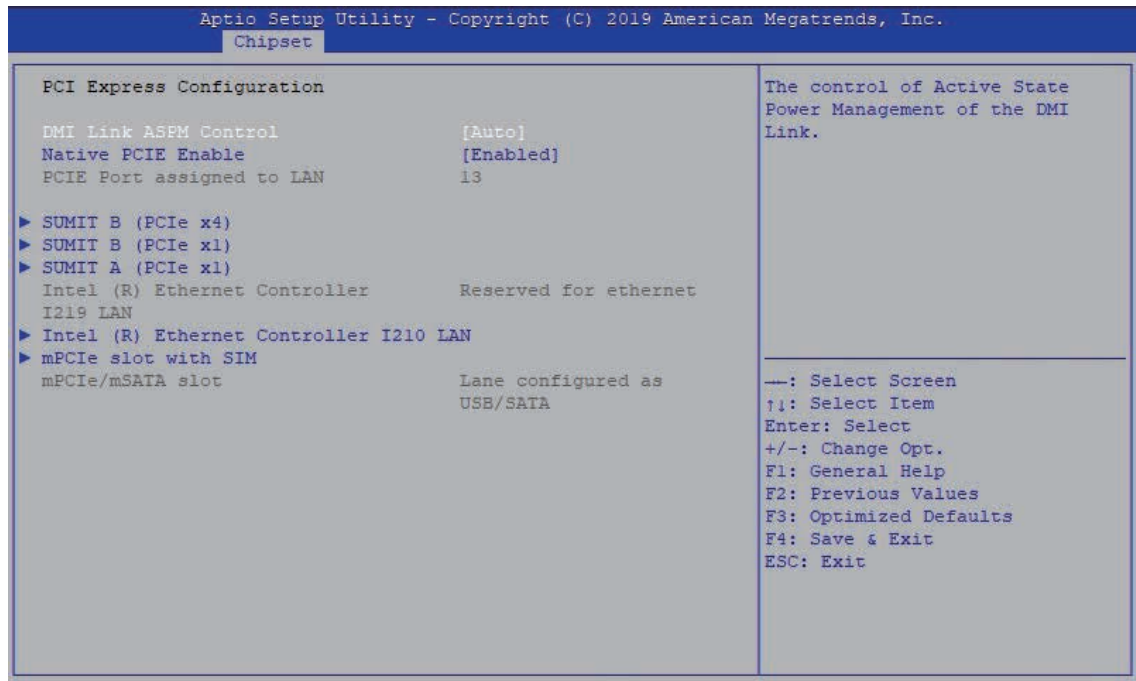

Figure 4-4-2-1 : PCI Express Configuration

DMI Link ASPM Control

The control of Active State Power Management of the DMI Link.

Native PCIE Enable

PCI Express Native Support Enable/Disable. This feature is available in Vista and beyond Windows OS.

PCI Express device settings

BIOS options for PCI Express device setting.

4.4.2.2 SATA And RST Configuration

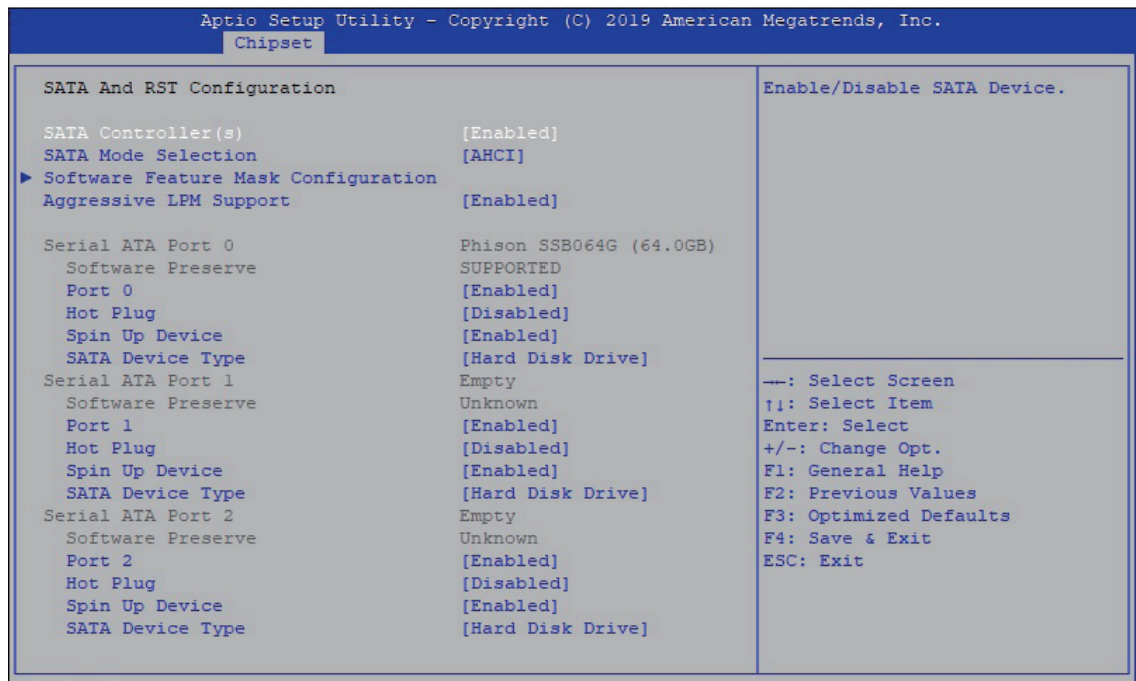

Figure 4-4-2-2 : SATA Devices Settings

SATA Controller(s)

Enable or disable SATA Device.

SATA Mode Selection

Determines how SATA controllers operate.

Software Feature Mask Configuration

RST Legacy OPROM/RST UEFI driver will refer to the SWFW configuration to enable/disable the storage features.

Aggressive LPM Support

Enable PCH to aggressively enter link power state.

Options for each SATA port.

Port n

Enable or disable SATA port.

Hot Plug

Designates this port as Hot Pluggable.

Spin Up Device

On an edge detect from 0 to 1, the PCH starts a COMRESET initialization sequence to the device.

SATA Device Type

Identify the SATA port is connected to Solid State Drive or Hard Disk Drive.

4.4.2.3 BIOS Security Configuration of PCH-IO

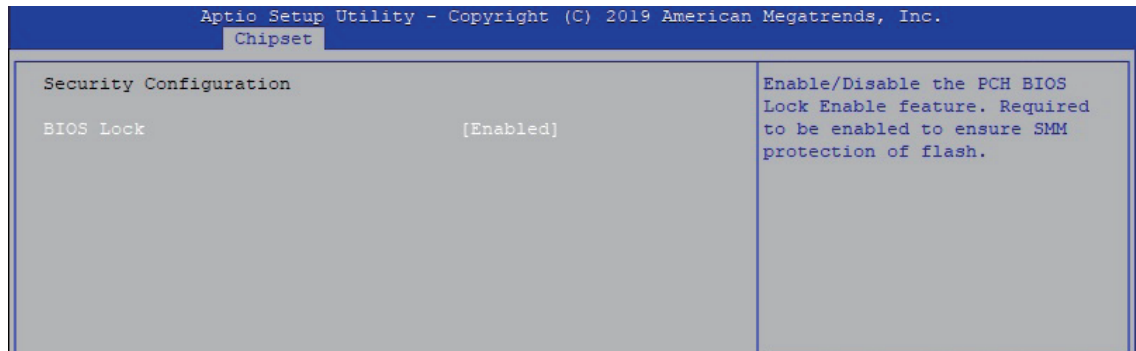

Figure 4-4-2-3 : BIOS Security Settings

BIOS Lock

Enable/Disable the PCH BIOS Lock Enable (BLE bit) feature.

4.4.3 LVDS Configuration

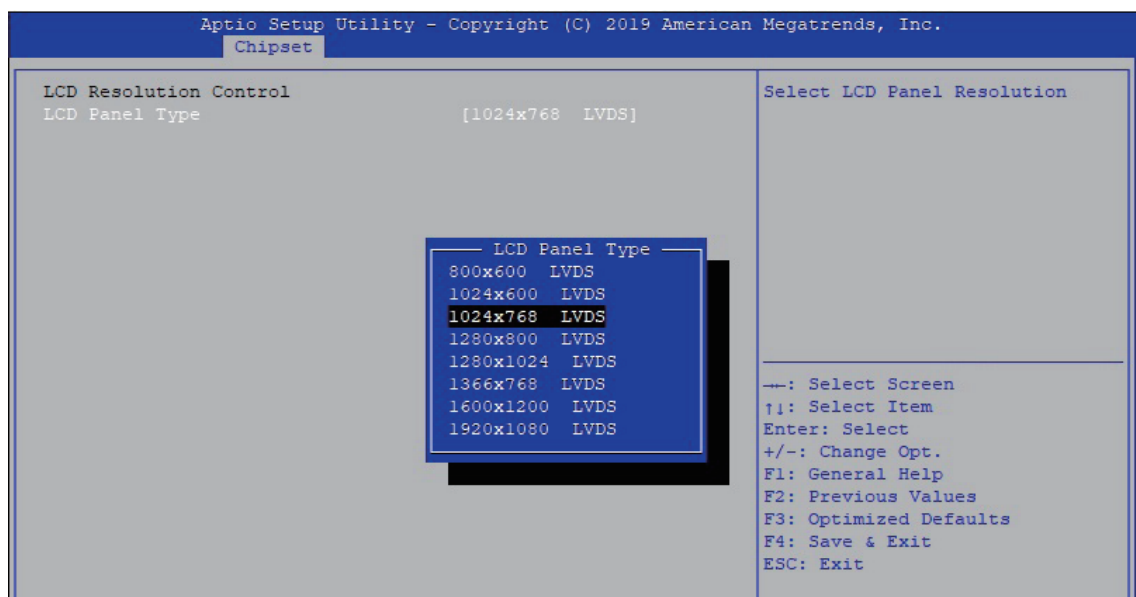

Figure 4-4-3 : LVDS Panel Settings

The LVDS Configuration option will be present if LVDS panel is connected on system.

LCD Panel Type

Select LCD Panel Resolution.

4.5 Security

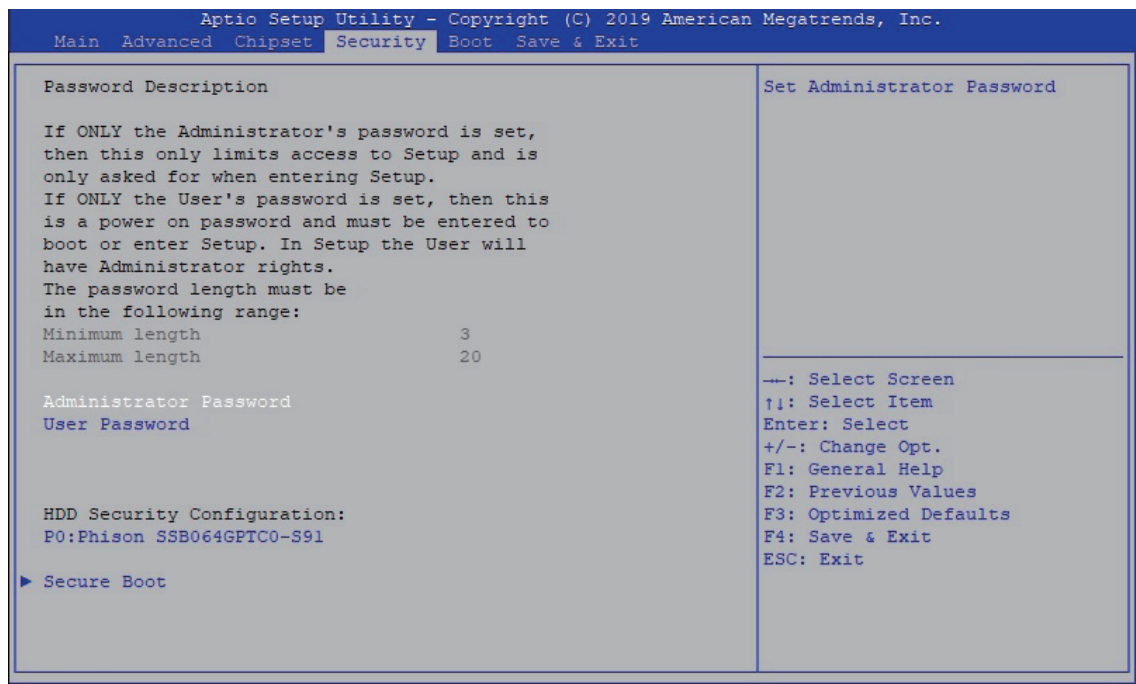

Figure 4-5 : BIOS Security Menu

Administrator Password

Set administrator password.

User Password

Set user password.

Secure Boot

Secure Boot configuration.

4.5.1 HDD Security Configuration

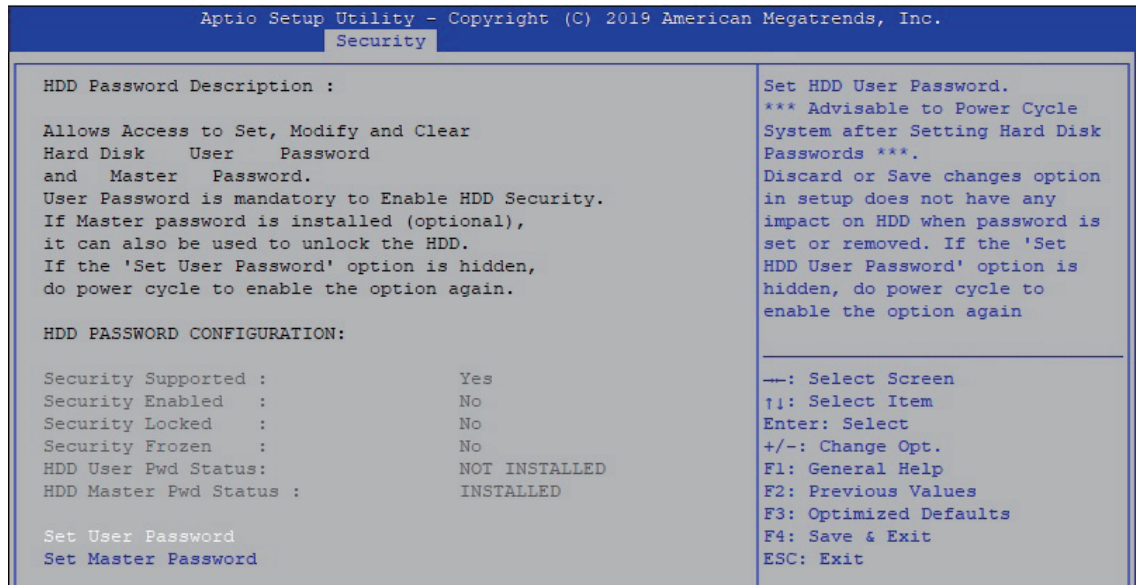

Figure 4-5-1 : HDD Security Settings

Set User Password

Set HDD user password.

*** Advisable to power cycle system after setting hard disk passwords***.

Discard or save changes option in setup does not have any impact on HDD when password is set or removed. If the 'Set HDD user Password' option is gray, do power cycle to enable the option again.

4.5.2 Security Boot



Figure 4-5-2 : Security Boot Settings

Secure Boot

Secure Boot feature is Active if Secure Boot is Enabled, Platform Key (PK) is enrolled and the System is in User mode. The mode change requires platform reset.

Secure Boot Mode

Secure Boot mode options : Standard or Custom.

In Custom mode, Secure Boot Policy variables can be configured by a physically present user without full authentication.

Key Management

Enables expert users to modify Secure Boot Policy variables without full authentication.

4.6 Boot Functions

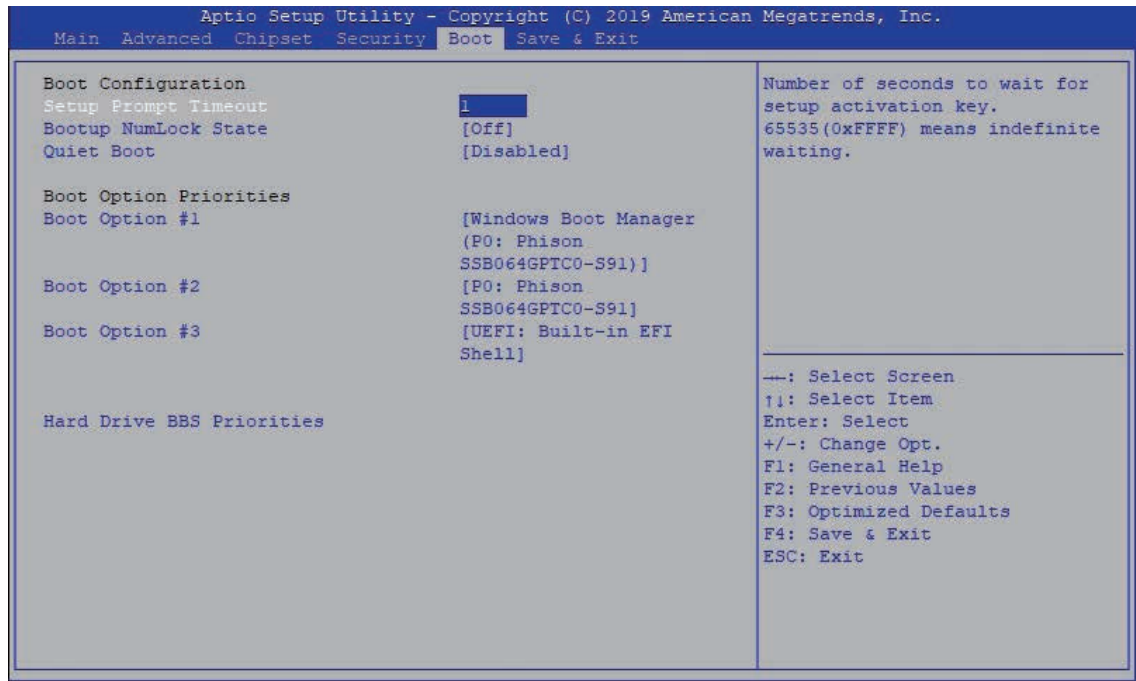

Figure 4-6 : BIOS Boot Menu

Setup Prompt Timeout

Number of seconds to wait for setup activation key. 65535 (0xFFFF) means indefinite waiting.

Bootup NumLock State

Select the keyboard NumLock state.

Quiet Boot

Enables or disables Quiet Boot option.

Boot Option #x

Sets the system boot order.

Hard Drive BBS Priorities

Set the order of the legacy devices in this group.

4.7 Save & Exit

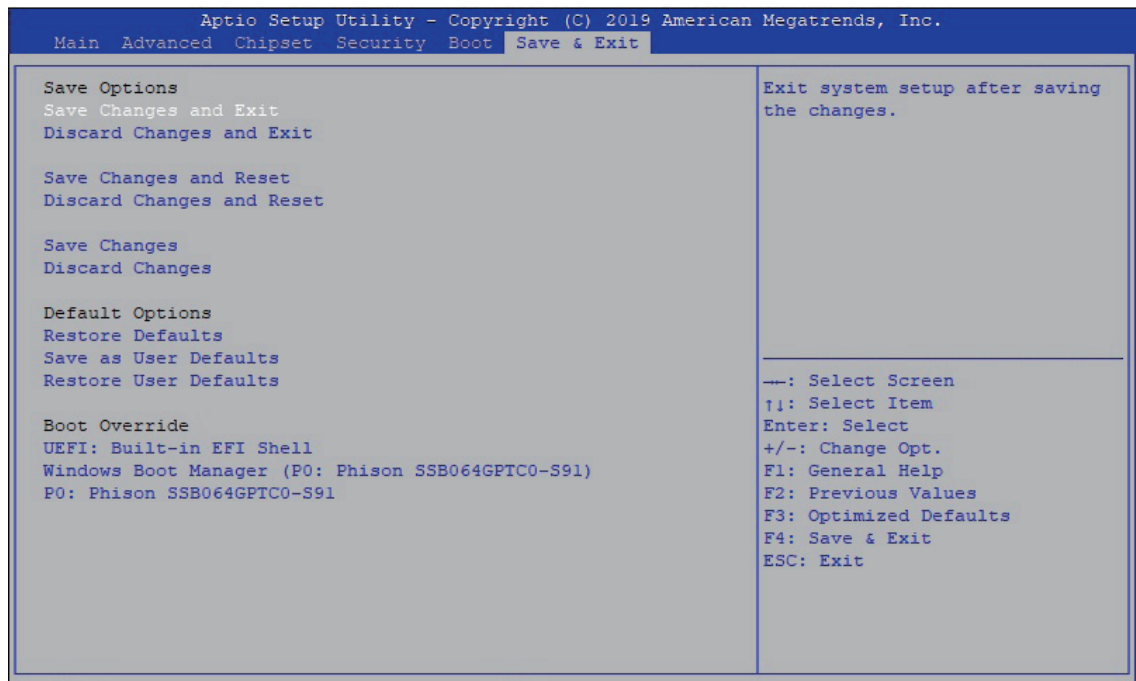

Figure 4-7 : BIOS Save and Exit Menu

Save Changes and Exit

Exit system setup after saving the changes.

Discard Changes and Exit

Exit system setup without saving any changes.

Save Changes and Reset

Reset the system after saving the changes.

Discard Changes and Reset

Reset system setup without saving any changes.

Save Changes

Save Changes done so far to any of the setup options.

Discard Changes

Discard Changes done so far to any of the setup options.

Default Options :

Restore Defaults

Restore/Load Default values for all the setup options.

Save as User Defaults

Save the changes done so far as User Defaults.

Restore User Defaults

Restore the User Defaults to all the setup options.

A

APPENDIX A : Isolated DIO Guide

A.1 Function Description

The ABP-3000 offers a 16-bit DIO (Isolated/Non-Isolated) 20-pin terminal block connector, a watchdog timer, and a 2-port POE.

Isolated DIO pins are fixed by Hardware design that cannot change in/out direction in runtime process.

DIO definition is shown below :

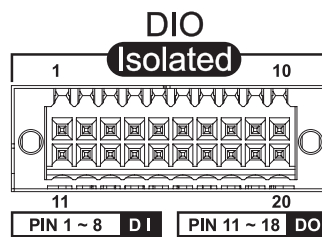

Pin No.	Isolated DIO Definition	Pin No.	Isolated DIO Definition
1	DI 0	11	DO 0
2	DI 1	12	DO 1
3	DI 2	13	DO 2
4	DI 3	14	DO 3
5	DI 4	15	DO 4
6	DI 5	16	DO 5
7	DI 6	17	DO 6
8	DI 7	18	DO 7
9	DI COM	19	DIO_GND
10	DIO_GND	20	External VDC

POE definition is shown below :

Do NOT use these functions in below :

1. PE-2000 : DIO1 (ID = 0), POE
2. PE-3000 : POE (ID = 0)
3. UE-1000 : USB (ID = 0)

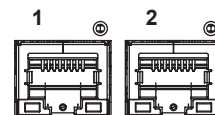

Pin No.	Definition
1	POE 0
2	POE1

A.2 Isolated DIO Signal Circuit

DI reference circuit :

Sink Mode
(NPN)

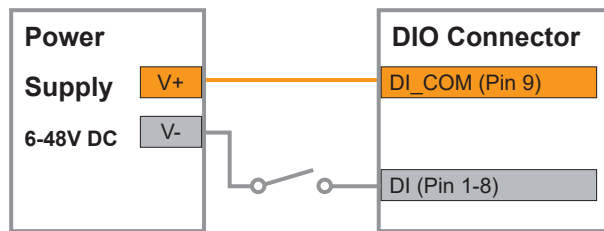

Source Mode
(PNP)

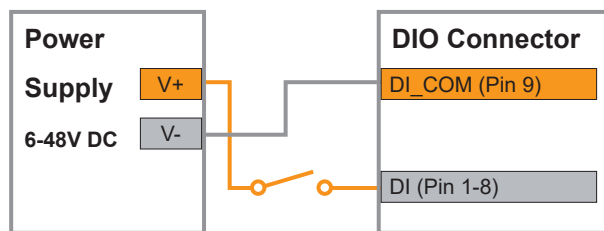

DO reference circuit :

Sink Mode
(NPN, Default)

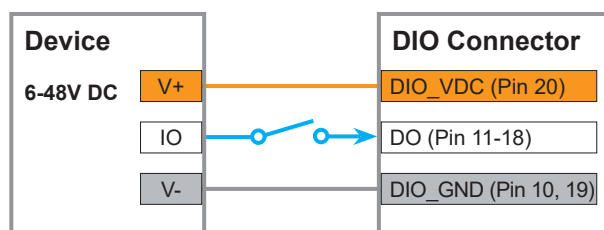

Source Mode
(PNP)

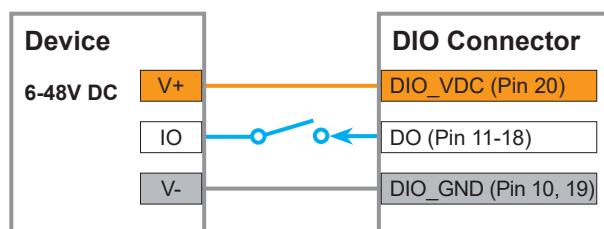

A.3 Software Package Contain

Distribution folder include x32 and x64 versions, use batch file for installation.

There are included as followed :

Win7_32.bat :

Installation for 32-bit driver

Win7_64.bat :

Windows update package which driver required (need to restart), and Installation for 64-bit driver

Win10_32.bat, and Win10_64.bat :

Installation for driver, and

Uninstall_32.bat, and Uninstall_64.bat :

Uninstallation for driver

Run batch file as Administrator.

Make sure Windows version before installation.

Header folder include head file for software developer or System Integration.

Manual folder include API description.

Sample folder include sample program, driver library, and API library for Windows/Linux

Source folder include sample program source code that compile on Visual Studio 2008/ubuntu16.04.

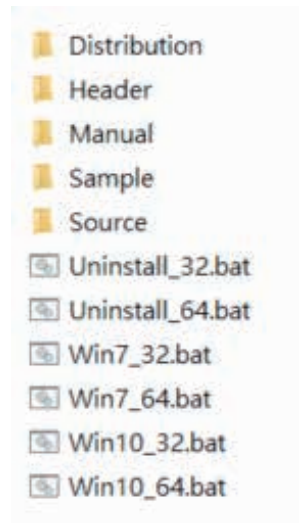

A.4 Sample

Execute demo tool.

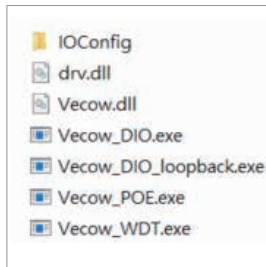

Windows

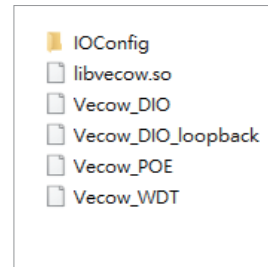

Linux

Sample, as shown below :

```
C:\Users\van\Desktop\x64\Vecow_DIO.exe
DIO sample version : v1.0.0609.0608
Load Vecow.dll at least v1.8.1409.0608
Vecow.dll Version : v1.8.1409.0608
Config : IO port I - Isolated DIO
         IO port II - Non-Isolated DIO(GPIO)
Choose IO : (1/2)
```

Vecow_DIO

```
C:\Users\van\Desktop\x64\Vecow_DIO_loopback.exe
DIO loopback sample version : v1.0.1509.0608
Load Vecow.dll at least v1.8.1409.0608
Vecow.dll Version : v1.8.1409.0608
Config : IO port I - Isolated DIO
         IO port II - Non-Isolated DIO(GPIO)
How many IO temp_port : (1/2)
```

Vecow_DIO_loopback

```
C:\Users\van\Desktop\x64\Vecow_POE.exe
POE sample version : v1.0.1609.0608
Load Vecow.dll at least v1.8.1409.0608
Vecow.dll Version : v1.8.1409.0608
Initial POE success!
Usable slave address ID : 0
Select slave address ID :
```

Vecow_POE

```
C:\Users\van\Desktop\x64\Vecow_WDT.exe
WDT sample version : v1.0.0509.0608
Load Vecow.dll at least v1.8.1409.0608
Vecow.dll Version : v1.8.1409.0608
Config : IO port I - Isolated DIO
         IO port II - Non-Isolated DIO(GPIO)
Set WDT timer seconds (1~3932100) :
```

Vecow_WDT

B

APPENDIX B : Software Functions

B.1 Driver API Guide

In Header folder, Vecow.h and VecowLinux.h contain usable API for Windows/Linux.

BOOL initial_SIO(BYTE Isolate_Type, BYTE DIO_NPN)

Initial machine for IO and watch dogtimer.

Isolate_Type : DIO type.

1 : Isolated DIO;

0 : Non-Isolated DIO(GPIO).

DIO_NPN : DI/DO type.

1 : PNP (Source) mode for European rule;

0 : NPN (Sink) mode for Japanese rule.

Return :

TRUE (1) : Success.

FALSE (0) : Fail (Driver not exists, or version is too old, or machine not match).

BOOL get_IO1_configuration(BYTE *Iso, BYTE *DI_mode, BYTE *DO_mode, WORD *Mask)

Get DIO configuration (by variable)

Isolate_Type : DIO type.

1 : Isolated DIO;

0 : Non-Isolated DIO(GPIO).

DI_mode ([7:0]) : DI type, pin setting by hexadecimal bitmask only for Isolated DIO.

0xFF : PNP (Source) mode for European rule;

0 : NPN (Sink) mode for Japanese rule.

DO_mode : DO type only for Isolated DIO.

1 : PNP (Source) mode for European rule;

0 : NPN (Sink) mode for Japanese rule.

Mask ([15:0]) : In/Out, pin setting by hexadecimal bitmask only for Non-Isolated DIO(GPIO).

1 : Output;

0 : Input

Return :

TRUE (1) : Success.

FALSE (0) : Fail (Initial error, or call by pointer error, or hardware problem).

BOOL set_IO1_configuration(BYTE Iso, BYTE DI_mode, BYTE DO_mode, WORD Mask)

Set DIO configuration.

Isolate_Type : DIO type.

1 : Isolated DIO;

0 : Non-Isolated DIO(GPIO).

DI_mode ([7:0]) : DI type, pin setting by hexadecimal bitmask only for Isolated DIO.

0xFF : PNP (Source) mode for European rule;

0 : NPN (Sink) mode for Japanese rule.

DO_mode : DO type only for Isolated DIO.

1 : PNP (Source) mode for European rule;

0 : NPN (Sink) mode for Japanese rule.

Mask ([15:0]) : In/Out, pin setting by hexadecimal bitmask only for Non-Isolated DIO (GPIO).

1 : Output;

0 : Input

Return :

TRUE (1) : Success.

FALSE (0) : Fail (Initial error or hardware problem).

BOOL get_DIO1(BYTE *DO_data, BYTE *DI_data)

Get isolated DIO output(DO) and input (DI).

DI ([7:0]) : Input state, pin setting by hexadecimal bitmask.

1 : High;

0 : Low.

DO ([7:0]) : Output state, pin setting by hexadecimal bitmask.

1 : High;

0 : Low.

Return :

TRUE (1) : Success.

FALSE (0) : Fail (Initial error, or call by pointer error, or hardware problem).

BOOL set_DIO1(BYTE DO_data)

Set isolated DIO output(DO).

DO ([7:0]) : Output state, pin setting by hexadecimal bitmask.

1 : High;

0 : Low.

TRUE (1) : Success.

FALSE (0) : Fail (Initial error or hardware problem).

BOOL get_WDT(DWORD *WDT)

Get watchdog timer setup.

WDT : watchdog timer setup.

Unit : second (Range : 0 ~ 65535 sec, 1093 ~ 65535 min (=65580 ~ 3932100 sec)).

Return :

TRUE (1) : Success.

FALSE (0) : Fail (Initial error, or call by pointer error, or hardware problem).

BOOL set_WDT(DWORD WDT)

Set watchdog timer setup.

WDT : watchdog timer setup.

Unit : second (Range : 0 ~ 65535 sec, 1093 ~ 65535 min (=65580 ~ 3932100 sec)).

Return :

TRUE (1) : Success.

FALSE (0) : Fail (Initial error, or setup 0, or hardware problem).

BOOL cancel_WDT()

Cancel watchdog timer.

Return :

TRUE (1) : Success.

FALSE (0) : Fail (Initial error or hardware problem).

BOOL initial_POE(BYTE Scan, BYTE ID)

Initial POE.

Scan : POEID scan type

2 : Auto scan;

1 : Manual setup.

ID : POE ID by manual setting.

Range : 0~15.

Return :

TRUE (1) : Success.

FALSE (0) : Fail (Driver not exists, or version is too old, or out of range error).

BOOL get_POE_configuration(BYTE ID, BYTE *Auto, BYTE *Mask)

Get POE configuration (by variable).

ID : POE ID.

Range : 0~15.

Auto ([3:0]) : Auto mode, pin setting by hexadecimal bitmask.

1 : Auto;

0 : Manual.

Mask ([3:0]) : DC Enable/Disable, pin setting by hexadecimal bitmask.

1 : Enable;

0 : Disable.

Return :

TRUE (1) : Success.

FALSE (0) : Fail (Initial error, or out of range error, or call by pointer error, or hardware problem)

BOOL set_POE_configuration(BYTE ID, BYTE Auto, BYTE Mask)

Set POE configuration (by variable).

ID : POE ID.

Range : 0~15.

Auto ([3:0]) : Auto mode, pin setting by hexadecimal bitmask.

1 : Auto;

0 : Manual.

Mask ([3:0]) : DC Enable /Disable, pin setting by hexadecimal bitmask.

1 : Enable;

0 : Disable.

Return :

TRUE (1) : Success.

FALSE (0) : Fail (Initial error, or out of range error, or hardware problem).

BOOL get_POE(BYTE ID, BYTE *POE)

Get POE state.

ID : POE ID.

Range : 0~15.

POE ([3:0]) : POE state, pin setting by hexadecimal bitmask.

1 : On;

0 : Off.

Return :

TRUE (1) : Success.

FALSE (0) : Fail (Initial error, or out of range error, or call by pointer error, or hardware problem).

BOOL set_POE(BYTE ID, BYTE POE)

Set POE state.

A. ID : POE ID.

Range : 0~15.

B. POE ([3:0]) : POE state, pin setting by hexadecimal bitmask.

1 : On;

0 : Off.

Return :

TRUE (1) : Success.

FALSE (0) : Fail (Initial error, or out of range error, or hardware problem).



APPENDIX C : RAID Functions

C.1.1 SATA Mode for RAID

1. Chipset → PCH-IO Configuration → SATA Mode Selection → Intel RST premium with Intel Optane System Acceleration (Whiskey Lake platform).

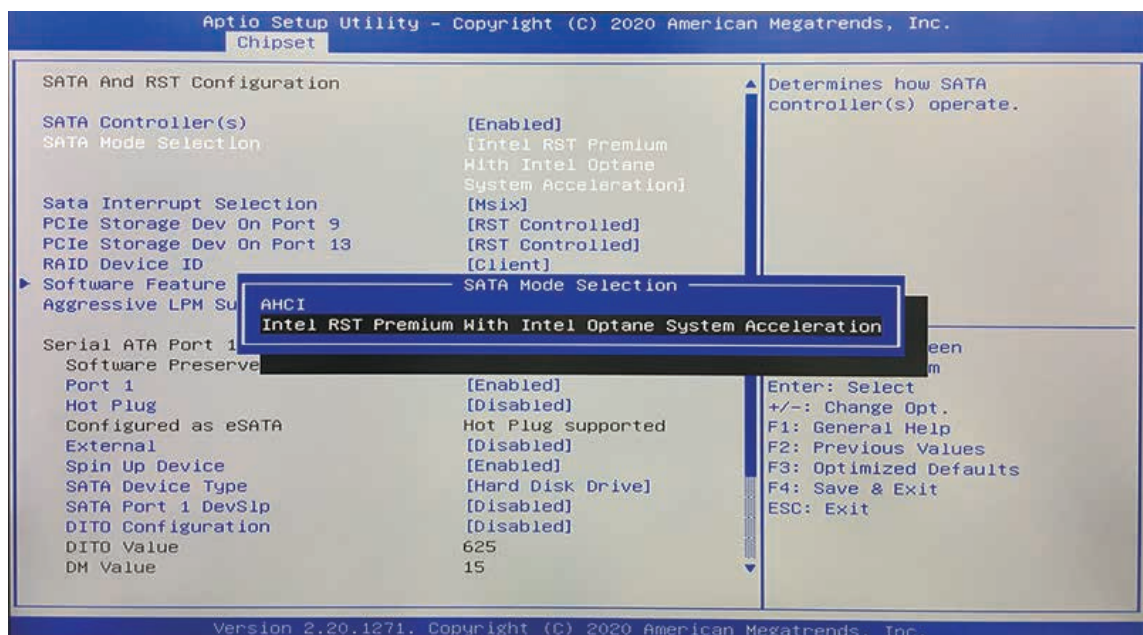

2. Both PCIe storage Dev on port 9 and port 13 needs to be selected as RST controlled.

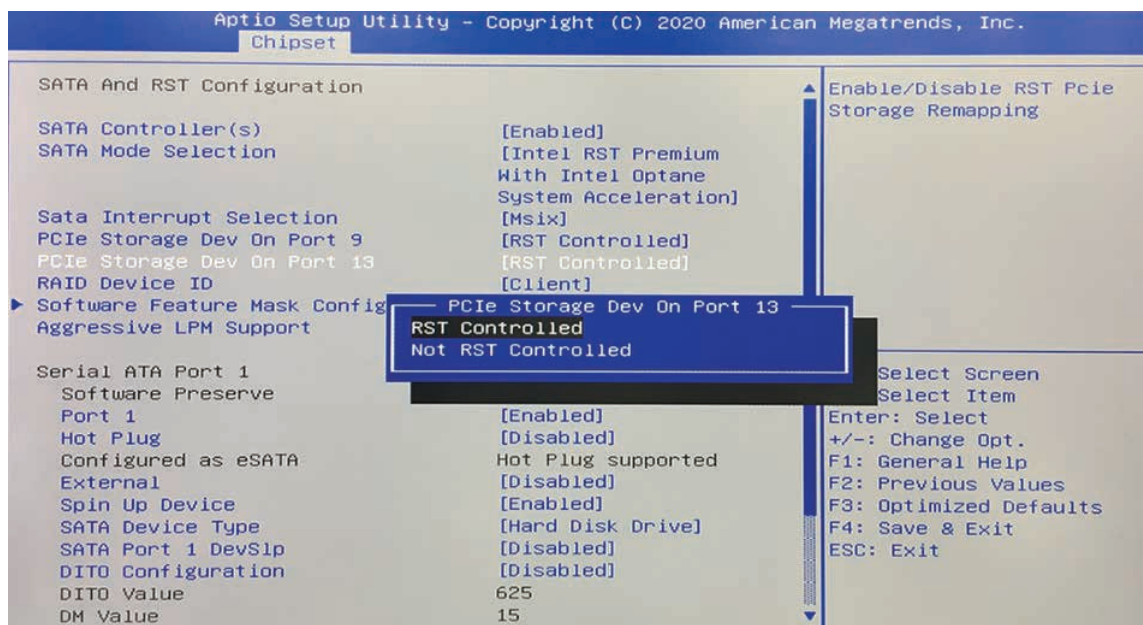

C.1.2 UEFI Mode for RAID

1. Please select Software Feature Mask Configuration on BIOS menu.

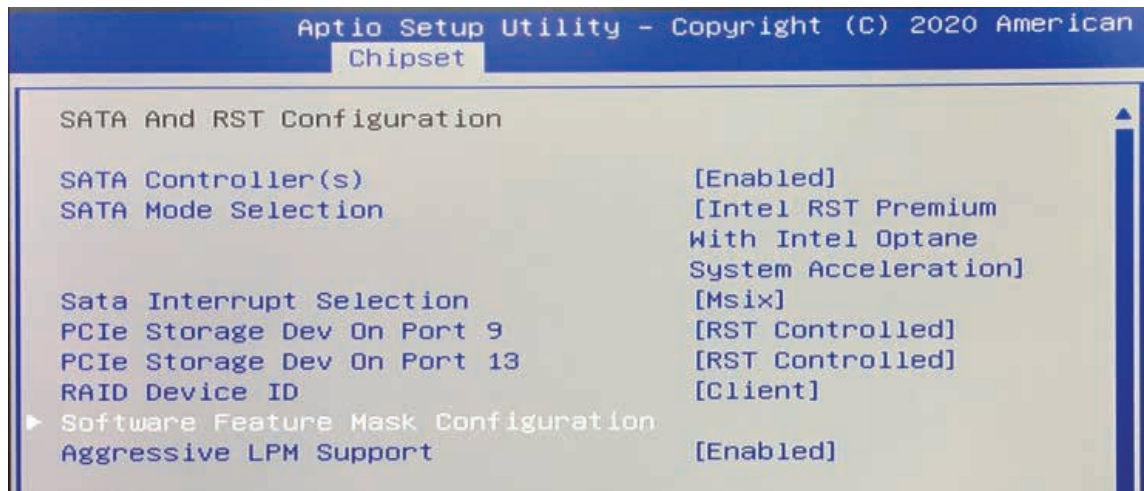

2. Use RST Legacy OROM → Disabled → Save Changes and Reset. When asked if you want to save changes, click "Yes".

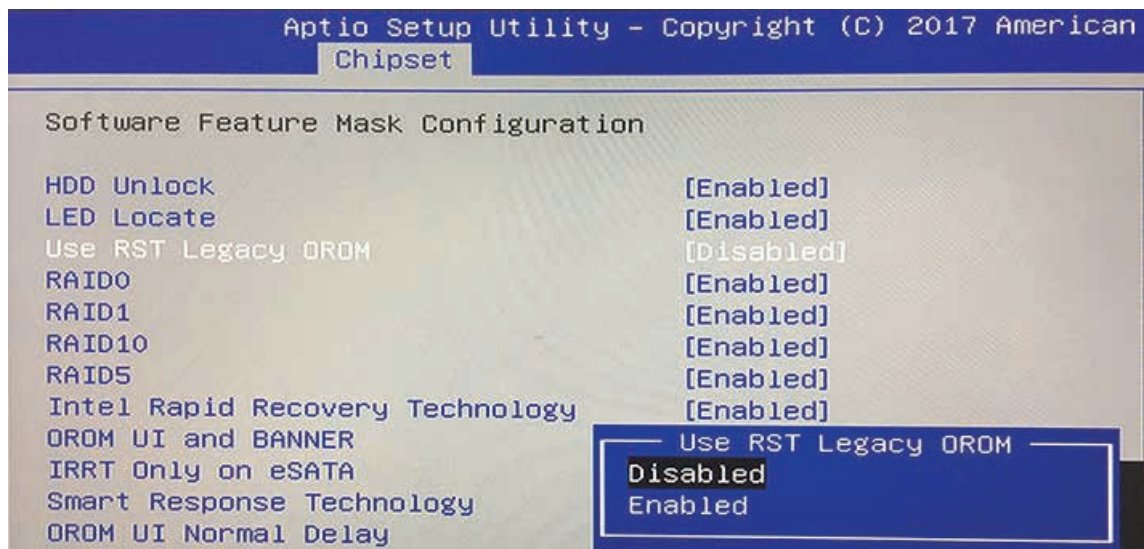

3. Access BIOS menu again, select Intel(R) Rapid Storage Technology.

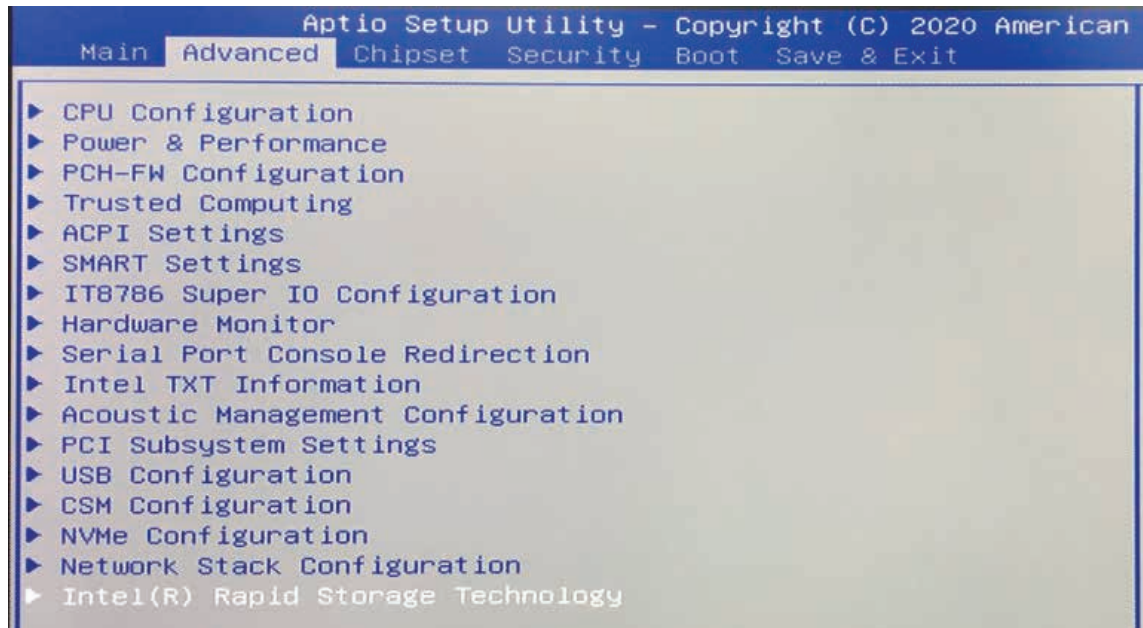

4. Select Create RAID Volume on BIOS menu.

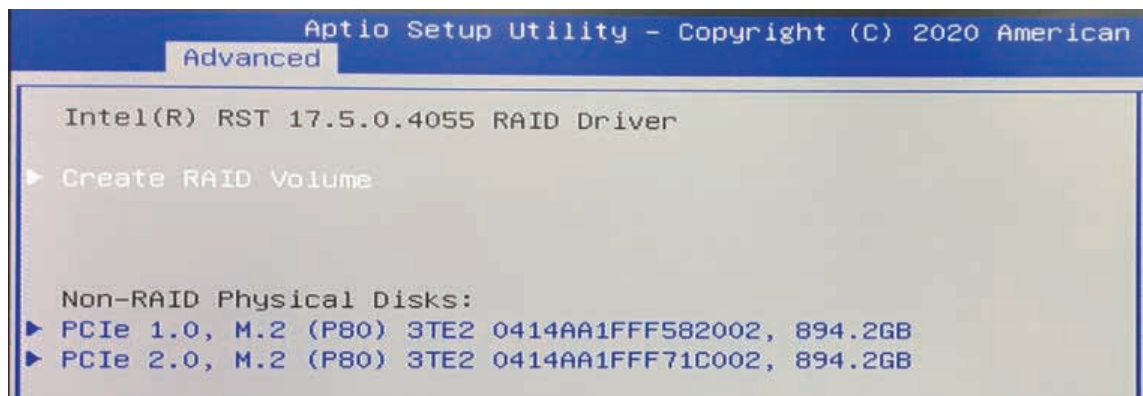

5. Select disks to create RAID Volume then Save Changes and Reset to install OS with EFI mode.

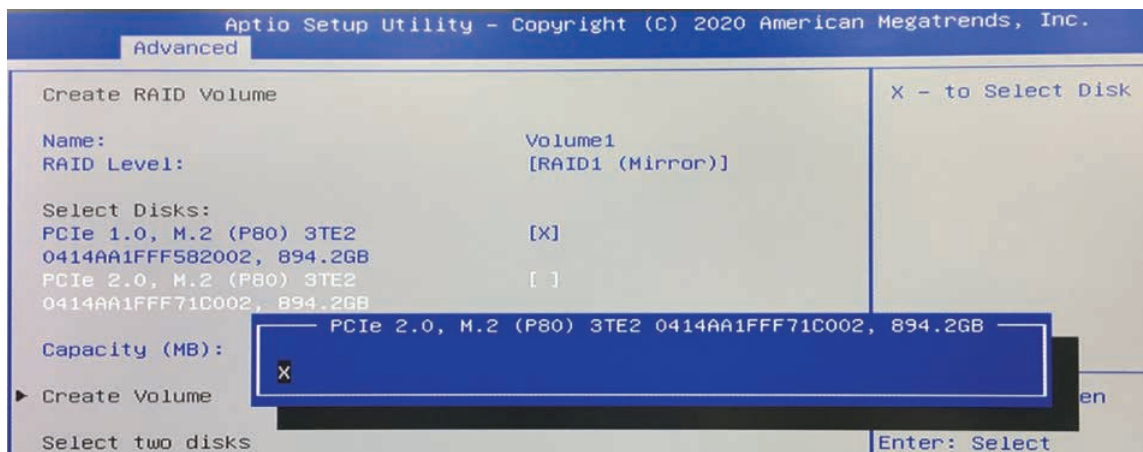

C.2 OS Installation

ABP-3000 is featured with two NVMe PCIe M.2 (2280) SSD storage.

We take two 1TB NVMe PCIe M.2 SSDs for Windows 10 OS installation as an example.

C.3 To Install All Device Drivers of the System

The instructions are as follows :

1. Install Chipset driver
2. Install Graphics driver
3. Install ME driver (if available)
4. Install Network driver
5. Install Audio driver
6. Install Intel® Rapid Storage Technology (Intel® RST) driver

C.4 To Install "Intel® Rapid Storage Technology (Intel® RST)" Software

You can get the software from the driver CD.

Also, you can find the latest information and software directly from Intel's website.

http://www.intel.com/p/en_US/support/highlights/chpsts/ims

The RAID environment has been done if you completed the steps above.

C.5 To Insert NVMe PCIe M.2 SSD for RAID 1

There are two M.2 SSD sockets on the system board. The computer support M.2 SSD cards.

Please note, you can use two M.2 SSD sockets for NVMe PCIe M.2 (2280) SSD.

C.6 To Create RAID Volume on "Rapid Storage Technology" Software

ABP-3000 is featured with two NVMe PCIe M.2 SSDs for RAID volume, so there are two options to choose on this page. Let's take RAID 1 as an example, select "RAID 1".

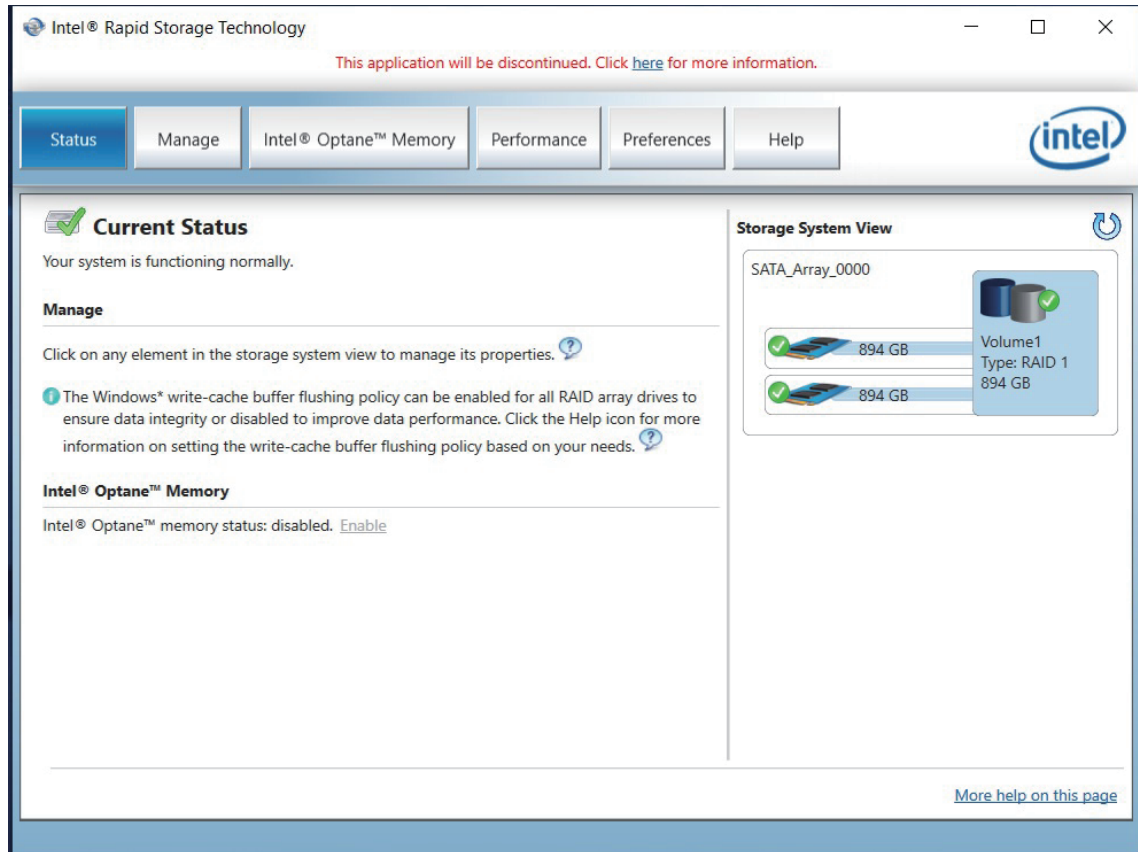

C.7 Disk Management : Partition the Disk

After RAID 1 volume is created, you can see the figure of M.2 storage device allocation.

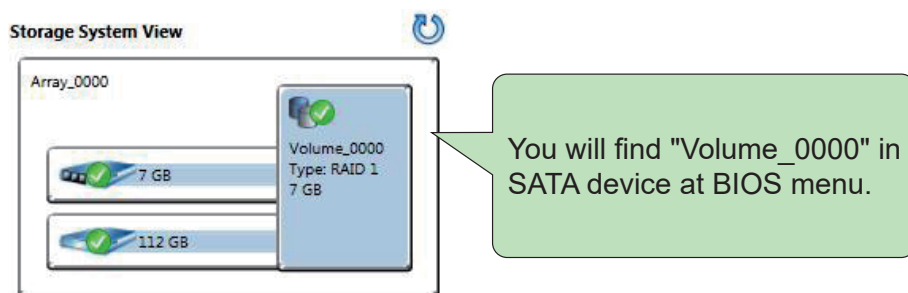

To start Disk Management tool and select "Initialize Disk".

Then add "Logical Device" for Windows access.

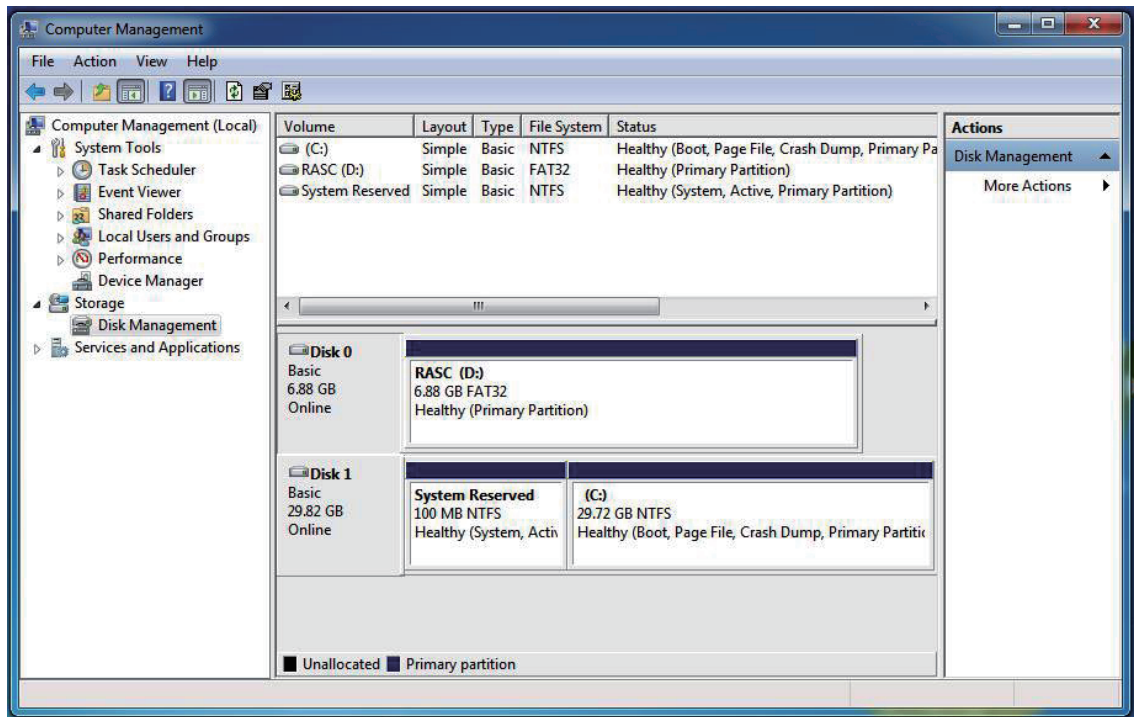

C.8 If One SATA HDD on RAID Volume is Out-of-use

After RAID 1 volume created, you can see the figure of SATA device allocation.

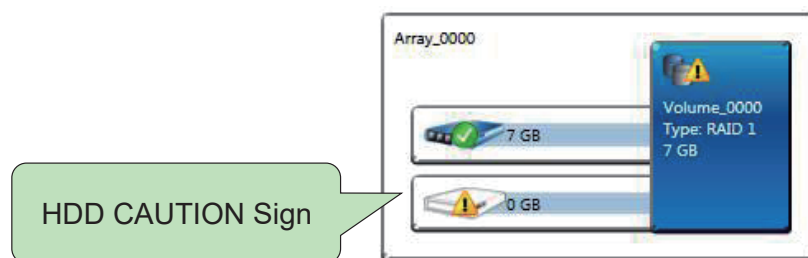

C.9 Recovery and Auto Re-build When Use the **SAME** RAID HDD

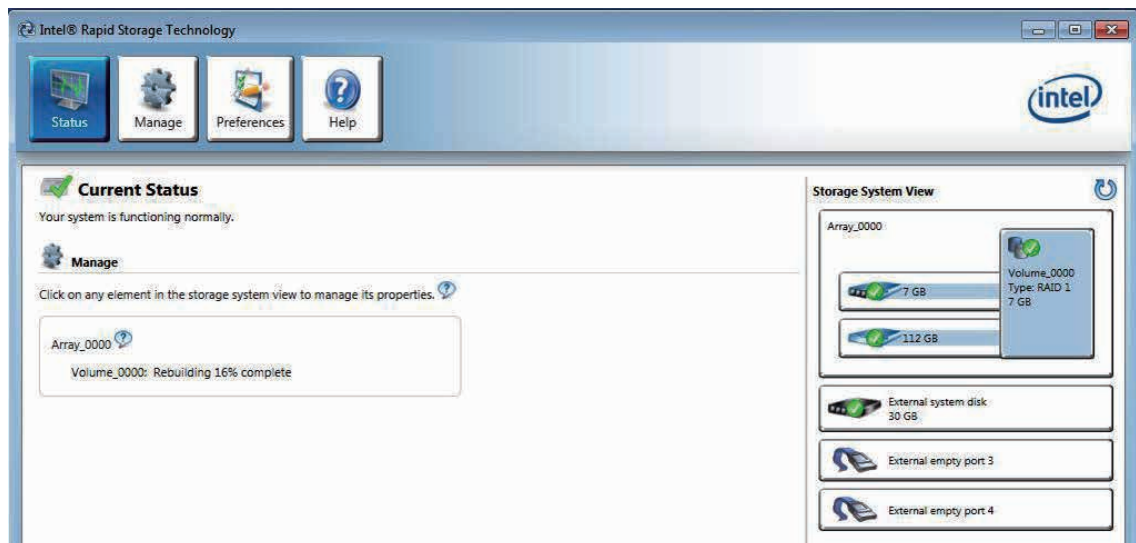

C.10 Recovery and Auto Re-build When Use **DIFFERENT** RAID HDD

There is a warning that will pop up to ask you if the disk is not a member of original RAID volume.

If you press "Rebuild", it will replace the broken SATA HDD to the last one SATA HDD of RAID volume.

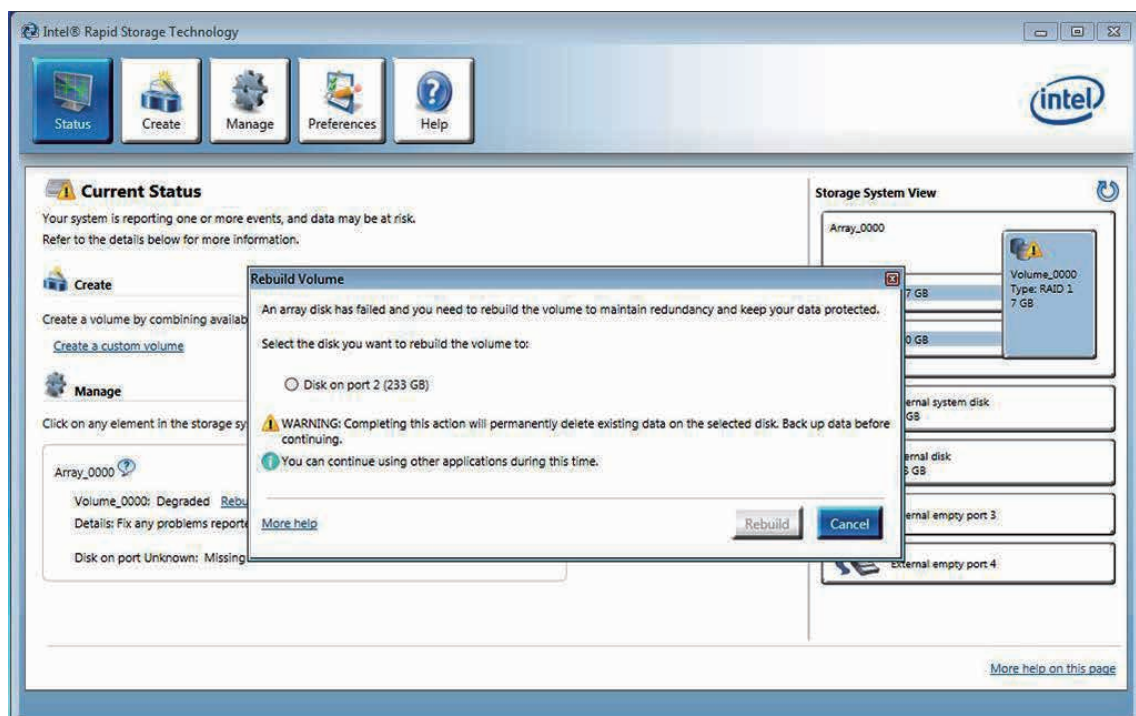

D

APPENDIX D : Power Consumption

Testing Board	EXBC-2000
RAM	16GB * 2
USB-1 : (USB 3.0)	USB Flash Transecnd 3.0 8GB
USB-2 : (USB 3.0)	USB Flash Transecnd 3.0 8GB
USB-3 : (USB 2.0)	USB Micsoft Wired Keyboard 600
USB-4 : (USB 2.0)	USB Mouse HP G1K28AA
M.2 PCIe SSD	INNODISK M.2 (P80) 3TG3-P 2TB SSD
LAN 1 (i350)	1.0 Gbps
LAN 2 (i350)	1.0 Gbps
LAN 3 (i350)	1.0 Gbps
LAN 4 (i350)	1.0 Gbps
Graphics Output	DP
Power Plan	Balance (Windows10 Power plan)
Power Source	Chroma 62006P-100-25

D.1 Intel® Core™ i7-8665UE 1.70GHz (8M Cache, up to 4.40GHz)

CPU	Power Input	Standby Mode		Power on and boot to Win 10 (64-bit)			
				Sleep Mode		idle status CPU usage less 3%	
		Max Current	Max Consumption	Max Current	Max Consumption	Max Current	Max Consumption
Core™ i7-8665UE	9V	0.322A	02.99W	0.406A	03.78W	1.289A	11.99W
	12V	0.253A	03.03W	0.318A	03.82W	0.996A	11.95W
	24V	0.156A	03.74W	0.188A	04.52W	0.494A	11.86W
	50V	0.108A	05.38W	0.124A	06.18W	0.264A	13.22W

CPU	Power Input	Power on and boot to Win10 (64-bit)			
		Run 100% CPU usage with 2D		Run 100% CPU usage with 3D	
		Max Current	Max Consumption	Max Current	Max Consumption
Core™ i7-8665UE	9V	2.100A	19.53W	3.079A	28.63W
	12V	1.753A	21.03W	2.360A	28.32W
	24V	0.882A	21.17W	1.172A	28.13W
	50V	0.455A	22.74W	0.590A	29.50W

D.2 Intel® Core™ i3-8145UE 2.20GHz (4M Cache, up to 3.90GHz)

CPU	Power Input	Standby Mode		Power on and boot to Win 10 (64-bit)			
				Sleep Mode		idle status CPU usage less 3%	
		Max Current	Max Consumption	Max Current	Max Consumption	Max Current	Max Consumption
Core™ i3-8145UE	9V	0.216A	02.01W	0.345A	03.21W	1.133A	10.53W
	12V	0.167A	02.00W	0.266A	03.19W	0.918A	11.01W
	24V	0.112A	02.69W	0.162A	03.88W	0.473A	11.36W
	50V	0.085A	04.23W	0.107A	05.36W	0.262A	13.08W

CPU	Power Input	Power on and boot to Win10 (64-bit)			
		Run 100% CPU usage with 2D		Run 100% CPU usage with 3D	
		Max Current	Max Consumption	Max Current	Max Consumption
Core™ i3-8145UE	9V	1.967A	18.29W	2.846A	26.47W
	12V	1.525A	18.30W	2.201A	26.41W
	24V	0.789A	18.95W	1.088A	26.12W
	50V	0.404A	20.19W	0.530A	26.49W

E

APPENDIX E : Supported List (Memory/M.2)

E.1 Test Item

Testing Board	EXBC-2000
Memory Test	MemTest86 V8.2
BurnIn Test	BurnInTest Pro V8.1 (build 1025)

Channel	Memory Test	Burn-in Test	Flash BIOS	Remove Battery	Sleep	Hibernate	Reset	CPU-Z
*2	PASS	PASS	PASS	PASS	PASS	PASS	PASS	PASS
*1 (DIMM 1)	PASS	PASS	PASS	PASS	PASS	PASS	PASS	PASS
*1 (DIMM 2)	PASS	PASS	PASS	PASS	PASS	PASS	PASS	PASS

E.2 Supported Non-ECC Memory List

Brand	Info	Test Temp. (Celsius)
innodisk 4GB DDR4-2400 WT SODIMM	M4S0-4GSSN5SJ-H03	25°C
innodisk 16GB DDR4-2400 ST SODIMM	M4S0-AGS1OCSJ-H03	25°C
innodisk 4GB DDR4-2666 ST SODIMM	M4S0-4GSSNCIK-H03	25°C
innodisk 4GB DDR4-2666 WT SODIMM	M4S0-4GSSN5IK-H03	25°C
Kingston 8GB DDR4-2666 ST SODIMM	KVR26S19S8/8	25°C
Vecow 8GB DDR4-2666 WT SODIMM	VMD4NIT-08G00A	25°C
Kingston 16GB DDR4-2666 ST SODIMM	KVR26S19D8/16	25°C
Vecow 16GB DDR4-2666 WT SODIMM	VMD4NIT-16G00A	25°C

E.3 Supported Storage List

Type	Brand	Model	Capacity
M.2 SSD (SATA)	Kingston	SUV500M8	960GB
	MEMXPRO	PM31 Series	512GB
M.2 SSD (PCIe)	Toshiba	KXG50ZNV512G	512GB
	Phison	ESMP256GTB3C2-E12	256GB
	Samsung	Samsung SSD 970 EVO Plus	250GB
	FORESEE	FSGMMC-256G	256GB
	Kingston	SA1000M8	240GB
		SA2000MB	500GB
	Intel	Intel® SSD 760p	128GB
	Panram	S27K002	960GB
	INNODISK	M.2 (P80) 3TG3-P	2TB
	MEMXPRO	PT33 ST series	1TB

F

APPENDIX F : Install Win11 (BIOS TPM Setting)

Step 1 Click on “Advanced”, then click on “PCH-FW Configuration”

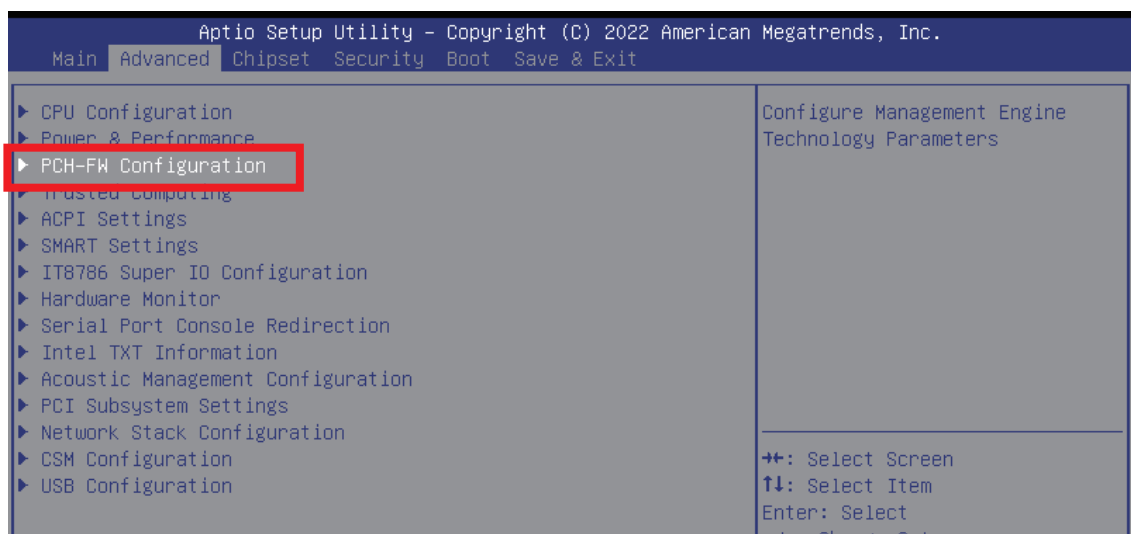

Step 2 Click on “PTT Configuration”

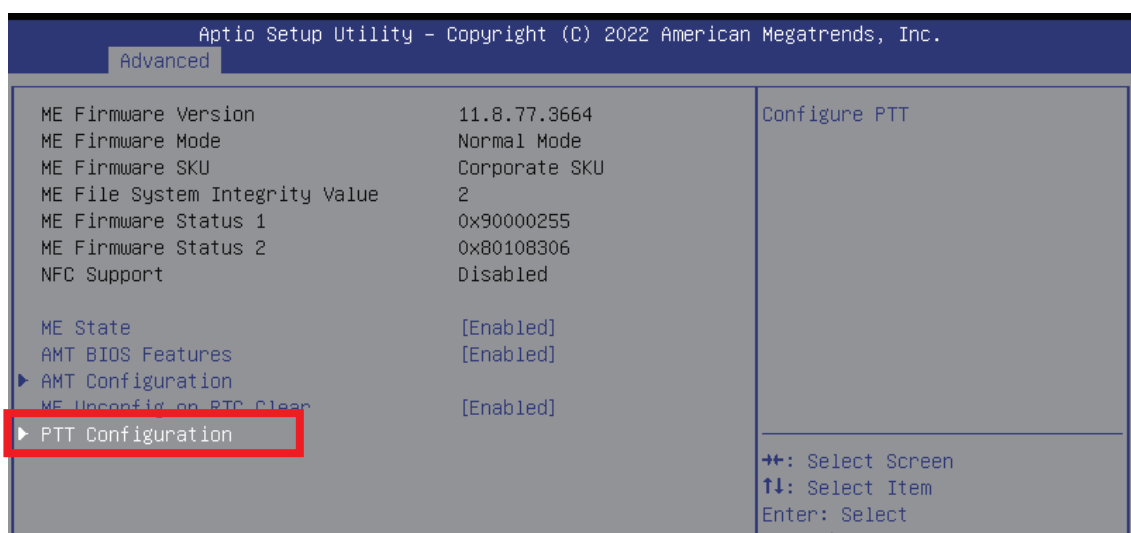

Step 3 Click on “dTPM” (TPM Device Selection)

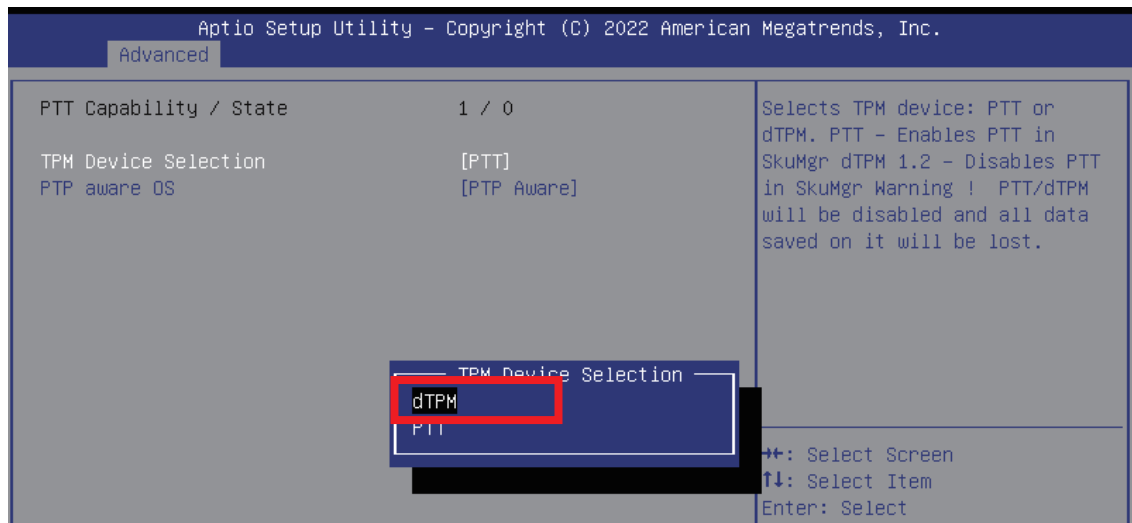

Step 4 Please save the BIOS settings by pressing F4. Please press Enter when the pop-up window which asks “Save configuration and exit?” appears. The computer will then restart.

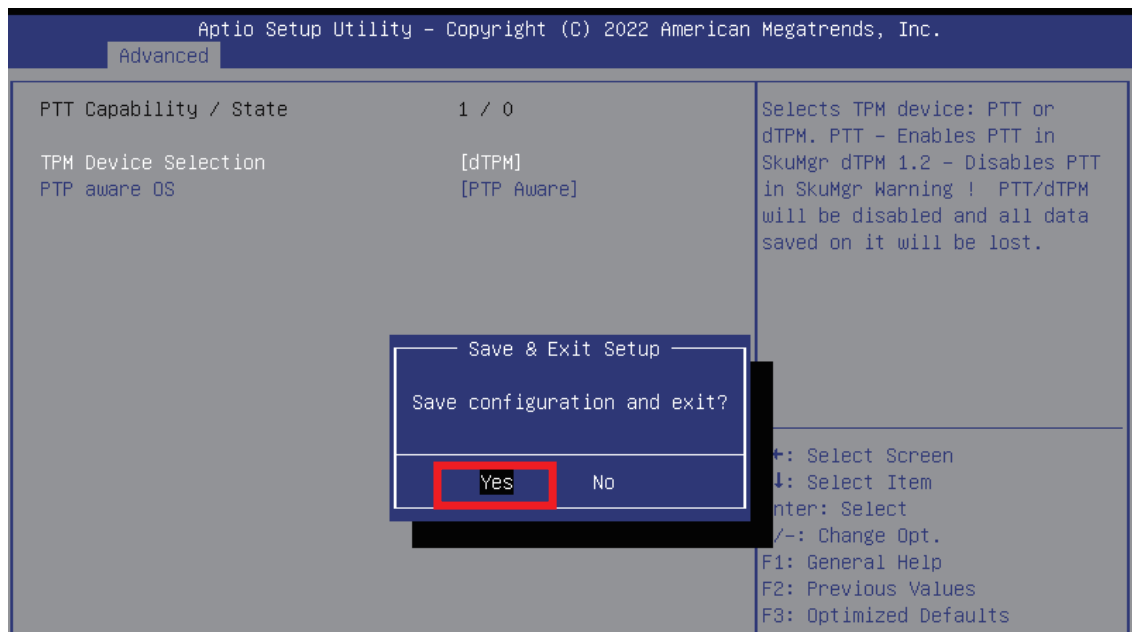

Step 5 Click on “Trusted Computing”

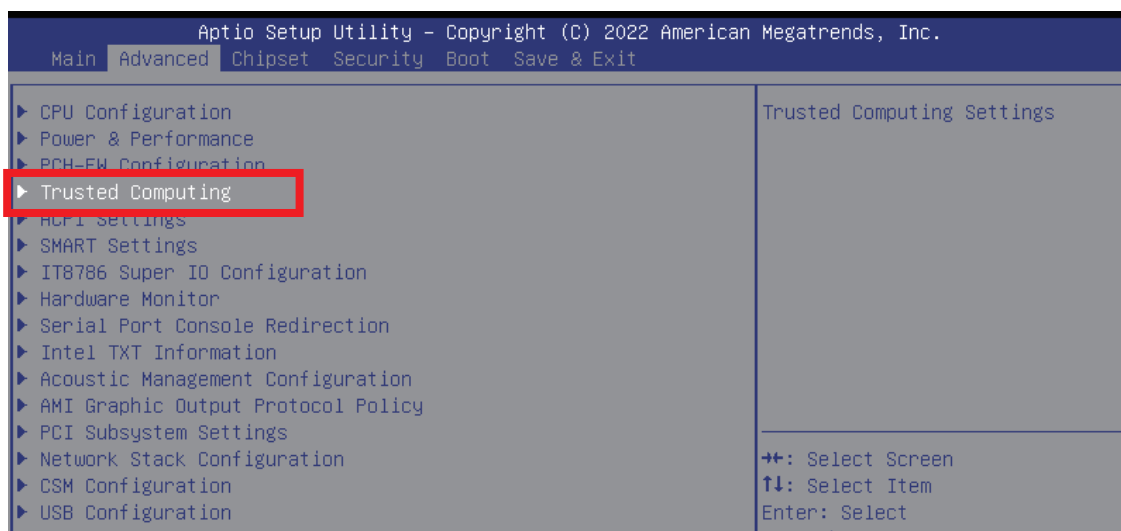

Step 6 If the window shows “TPM2.0 Device Found Firmware Version:5.62”, then the setting is completed.

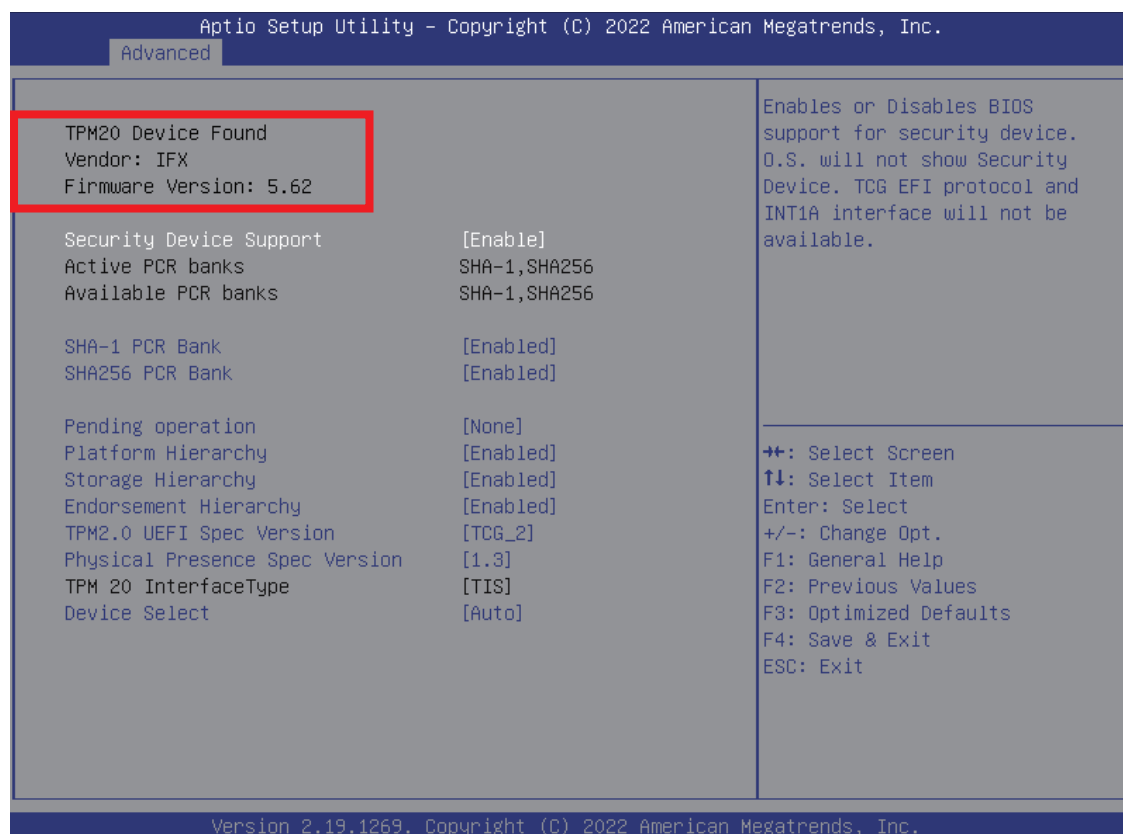

** If more help is needed, please contact Vecow technical support **



For further support information, please visit www.vecow.com

This document is released for reference purpose only.

All product offerings and specifications are subject to change without prior notice.

No part of this publication may be reproduced in any form or by any means, electric, photocopying, or recording, without prior authorization from the publisher.

The rights of all the brand names, product names, and trademarks belong to their respective owners.

© Vecow Co., Ltd. 2023. All rights reserved.